

Off-Grid Hybrid Inverter

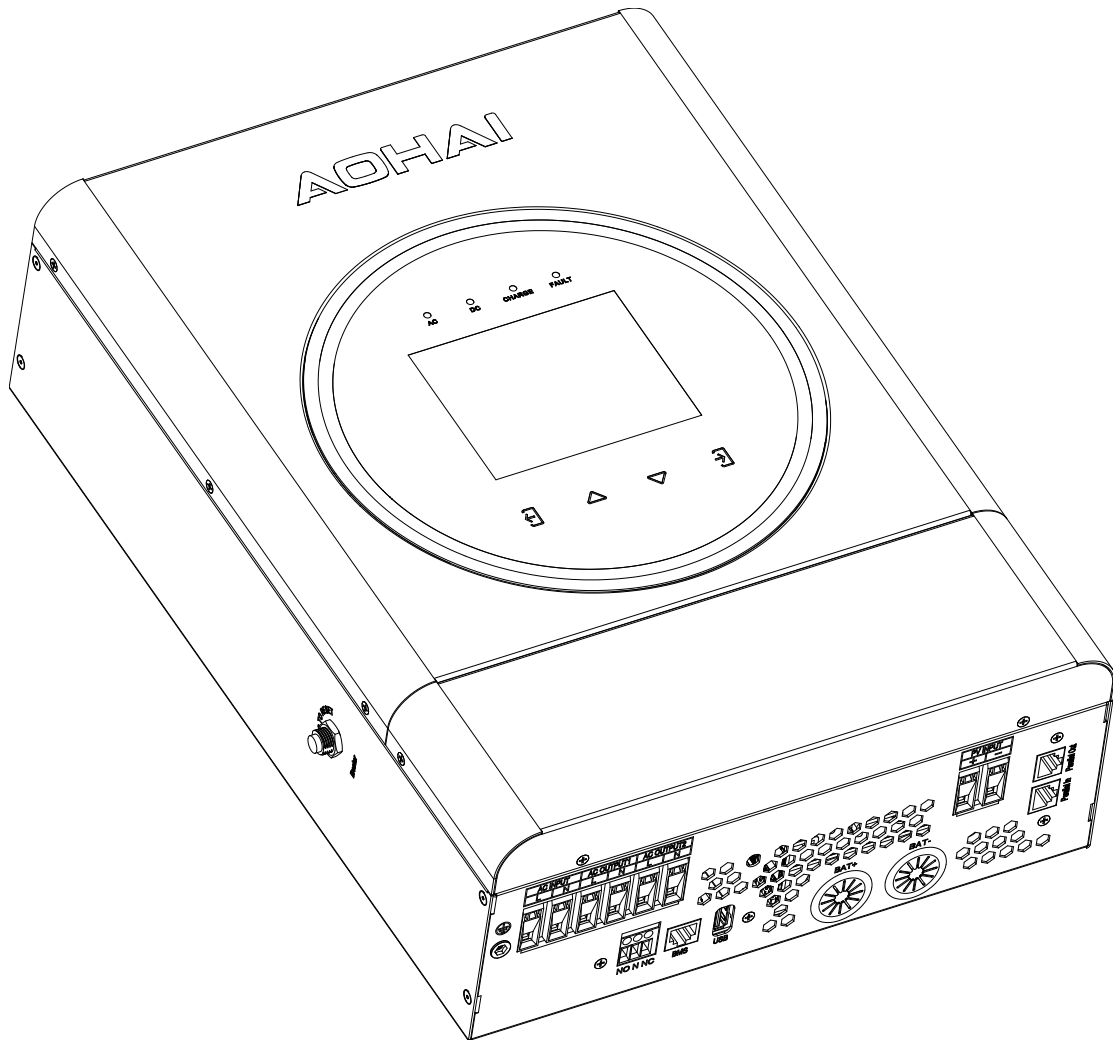

Product Model

FSA-3-4K1P-BL

Important Instructions

The instructions contain all the safety alerts, installation instructions, and operation instructions of the FSA-3-4K1P-BL Off-grid Hybrid Inverter. Please read the instructions carefully before installation and use, and properly keep it for future reference.

- There is an unsafe voltage in the device. Do not disassemble the device by yourself in case of electric shock. Please contact the local qualified service center for repair.
- The mains input and AC output are of high voltage. Please do not touch the wire connection.
- In order to reduce the risk of electric shock, please disconnect all wires before maintenance.
- Do not open the terminal cover when the device is under operation to prevent the electric shock.
- The device shall be installed by qualified professionals.
- Do not place or install the inverter in a place accessible to children.
- Do not install the inverter in a humid, greasy, flammable, explosive, dusty, or other harsh environment.
- Do not touch the hot shell when the device is under operation.
- It is recommended to install a proper fuse or circuit breaker outside the inverter.
- Disconnect the fuse or circuit breaker near the Photovoltaic (PV) array, mains, and battery terminals with insulating gloves, before installation and adjustment of the wiring of the inverter.
- After installation, please check whether all wires are tightly connected in case of fire hazards due to heat accumulation generated by loose connections.
- The inverter is an off-grid device. Please ensure that the inverter is the only power source of the load. Do not use it in parallel with other AC power sources in case of damage to the inverter and electrical appliance.
- In order to reduce the risk of injury, only deep-cycle rechargeable batteries can be used if using lead-acid battery.

Table of Contents

目录

| | |
|---|-----------|
| Important Instructions | 2 |
| 1. Basic Information | 4 |
| 1.1 Product Overview and Features | 4 |
| 1.2 Introduction to the Basic System | 4 |
| 1.3 Product Appearance | 5 |
| 1.4 Dimensional Drawing | 6 |
| 2. Installation Instructions | 7 |
| 2.1 Installation Precautions | 7 |
| 2.2 Installation Tools | 8 |
| 2.3 Wiring Specifications and Circuit Breaker Selection | 9 |
| 2.4 Installation and Wiring | 10 |
| 2.5 Parallel Connection and Wiring | 16 |
| 3. Working Modes | 32 |
| 3.1 Power Supply Modes | 32 |
| 3.2 Charging Modes | 34 |
| 3.3 Battery Charging Parameters | 35 |
| 4. Operating Instructions for LCD Screen | 37 |
| 4.1 Operation and Display Panel | 37 |
| 4.2 Parameter Settings | 40 |
| 5. Other Functions | 47 |
| 5.1 RS485 Communication Function | 47 |
| 5.2 USB Port Function | 47 |
| 5.3 Dry Contact Function | 48 |
| 5.4 Wi-Fi Wireless Communication Function | 49 |
| 6. APP Instructions | 49 |
| 7. Protection | 50 |
| 7.1 Error Code | 50 |
| 7.2 Troubleshooting (partial) | 51 |
| 8. System Maintenance | 52 |
| 9. Technical Parameters | 52 |

1. Basic Information

1.1 Product Overview and Features

This device is a new hybrid solar energy storage inverter integrating solar energy storage, grid charging & storage, and AC sine wave output. Controlled by the digital signal processor (DSP), the inverter has high response speed, high reliability, high standards, and other features. Its charging and AC output modes are optional to meet the characteristics of different application scenarios.

Features:

- Simplified charging modes: solar energy charging only/solar energy charging priority/hybrid charging. Each mode maximizes the use of solar energy.
- An uninterruptible power supply (UPS) function with three types of AC outputs such as grid bypass, inverter output, and hybrid power supply.
- Up to 120A maximum current for long-time charging.
- Long-term 4KW discharging at full power output without derating.
- Supports both lead-acid batteries and lithium batteries.
- Up to 18A PV input current.
- Independent input port for the diesel generator.
- USB disk upgrade and online upgrade.
- Dual outputs for smart load management.

1.2 Introduction to the Basic System

The basic application of the inverter is shown in the following figure. The complete operating system includes:

- Generator or grid
- PV module
- Battery
- Domestic load
- Energy storage inverter

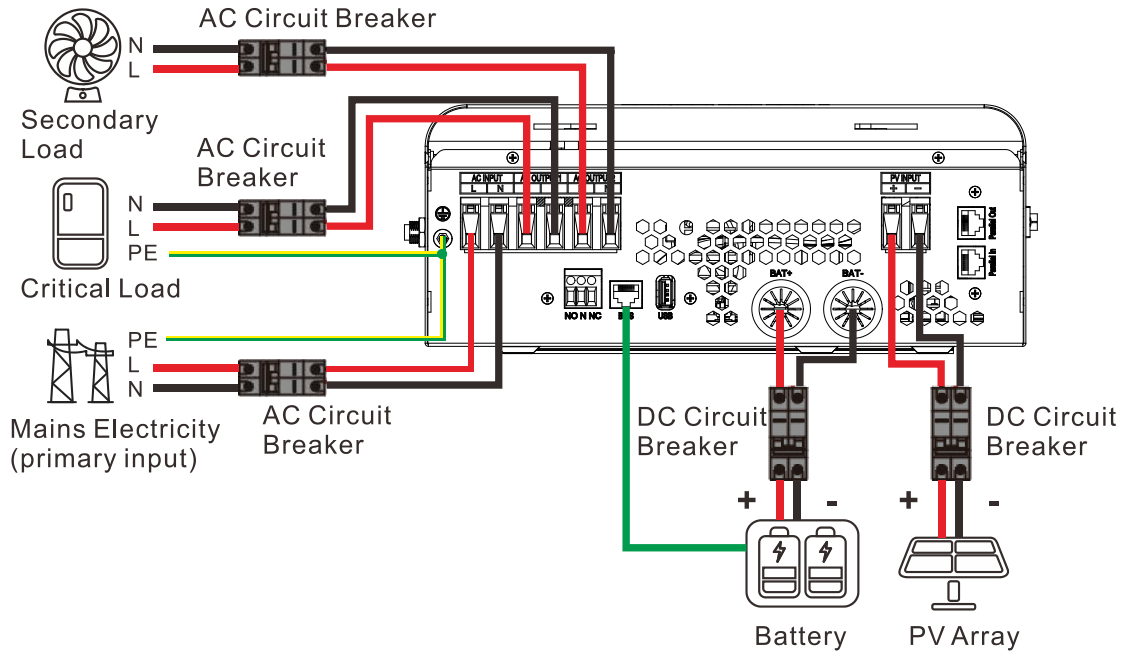

1.3 Product Appearance

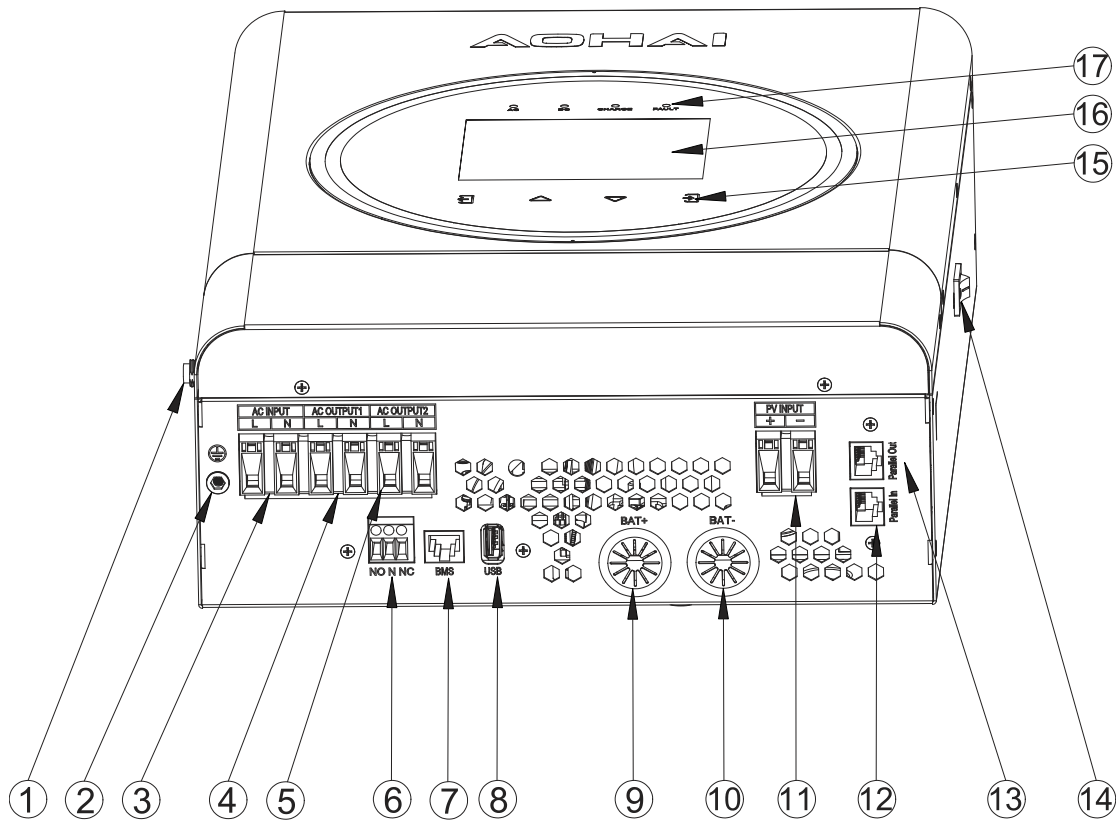

| | | | |
|---|---------------------------------|---|--------------------------------------|
| ① | Overload protector for AC input | ⑩ | Input port for battery cathode |
| ② | Ground screw hole | ⑪ | PV input port |
| ③ | AC input port | ⑫ | There is no such interface available |
| ④ | AC output port 1 | ⑬ | There is no such interface available |

| | | | |
|---|------------------------------|---|-------------------------|
| ⑤ | AC output port 2 | ⑭ | ON/OFF rocker switch |
| ⑥ | Dry contact port | ⑮ | Capacitive touch button |
| ⑦ | BMS communication port | ⑯ | LCD screen |
| ⑧ | USB communication port | ⑰ | horse race lamp |
| ⑨ | Input port for battery anode | | |

1.4 Dimensional Drawing

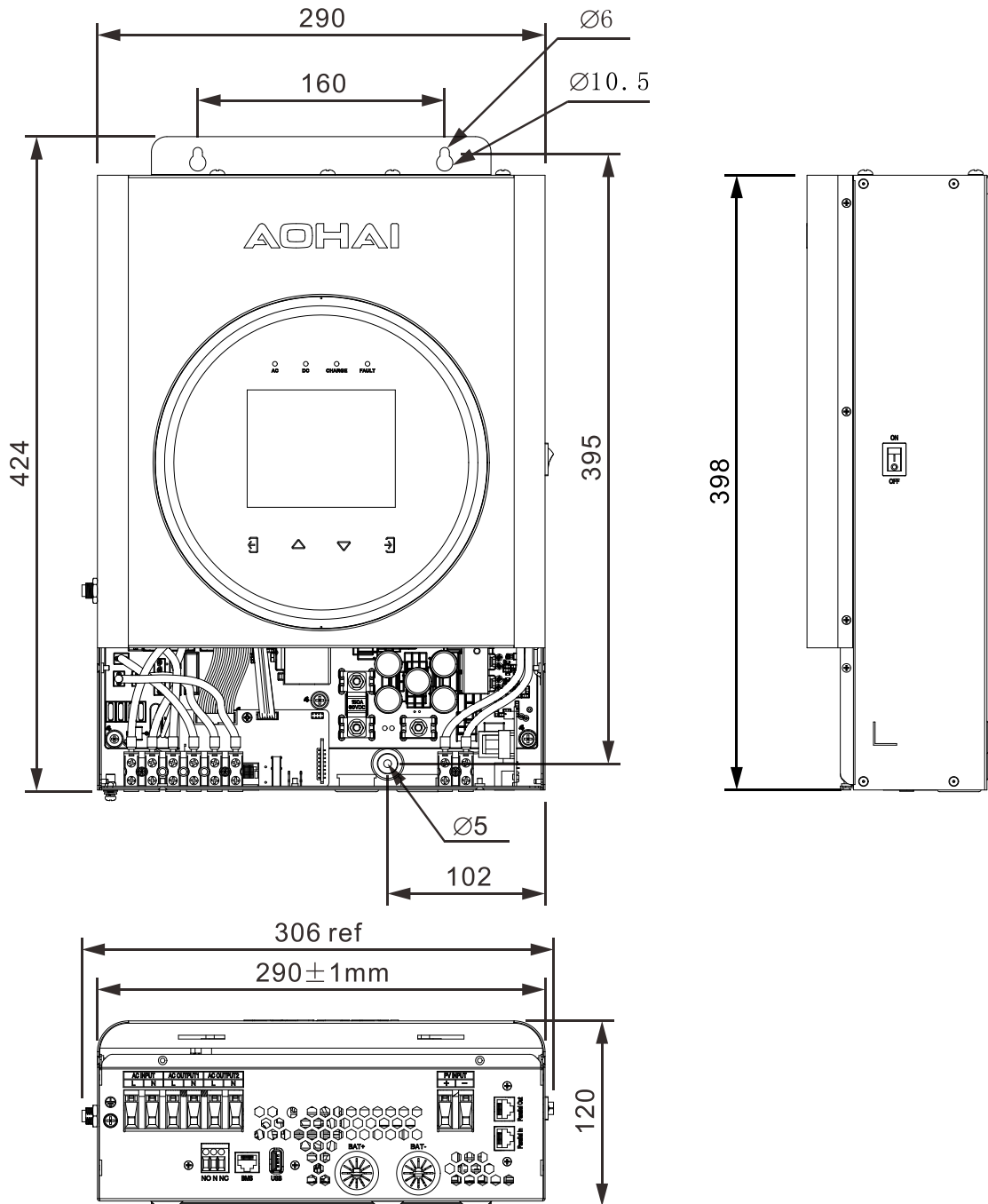

2. Installation Instructions

2.1 Installation Precautions







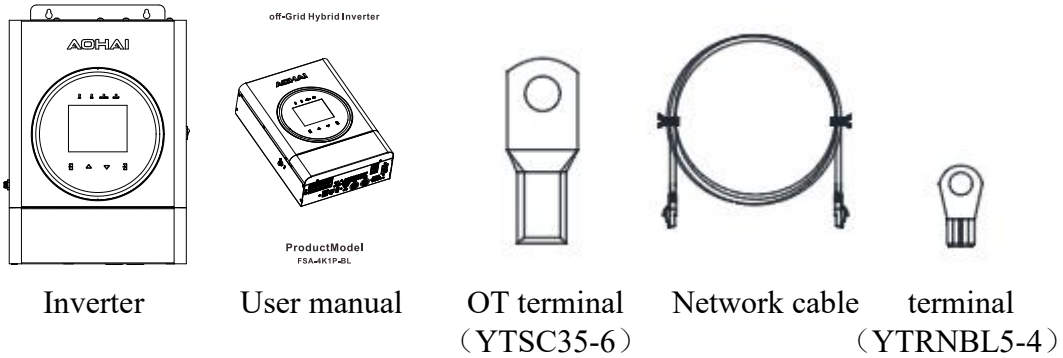

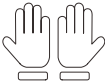

Before installation, please carefully read this manual to understand the procedures and get familiarized with the precautions.

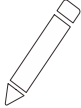
- Be careful when installing the battery. Please wear protective goggles when installing the lead-acid liquid battery, and rinse with clean water promptly in case of any contact with battery acid.
- Keep the battery away from metal objects in case of short circuits.
- Make sure the environment is well-ventilated because acid gas may be generated when the battery is charged.
- Leave enough space around the inverter for heat dissipation. Do not install the inverter and the lead-acid liquid battery in the same cabinet in case that acid gas generated by the battery corrodes the inverter.
- Only charge the battery compatible with the inverter.
- Loose connectors and corroded wires may cause great heat and melt the wire insulation layer, burn the surrounding materials, and even cause a fire, so please make sure that the connectors are tightened and the wires are preferably fixed with cable ties in case of loose connectors caused by the wobbling wires during movement.
- Select connecting wires with a current density less than $5\text{A}/\text{mm}^2$ for the system.
- Avoid direct sunlight and rainwater in outdoor installation.
- After the power switch is turned off, a high voltage is still inside the inverter. Do not open or touch the internal components until the capacitor completely discharges.
- Do not install the inverter in a humid, greasy, flammable, explosive, dusty, or other harsh environment.
- It is forbidden to reversely connect the input ends of the battery. Otherwise, it may lead to the damage of the device or unpredictable risks.
- The grid input and AC output are of high voltage. Please do not touch the wire connection.
- Do not touch the operating fan in case of injury.

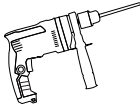
- Make sure that the inverter is the only power source of the load. Do not use it in parallel with other AC power sources in case of damage.
- Please check the machine before installation to make sure there is no damage in the packaging. You should receive the following items in your package

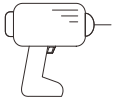
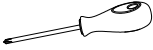
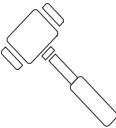

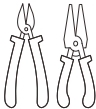
2.2 Installation Tools

| | | | | |
|---|---|--|---|---|
| Installation Tools | Multi-meter | Protective gloves | Insulated anti-smashingshoes | Marking pen |
| |  |  |  |  |
| | Safety glasses | Hammer drill | ESD wrist strap | Hot air gun |
| |  |  |  |  |
| Electric screw driver | Cross screw driver | Rubber mallet | Hexagonal nut sleeve | |
|  |  |  |  | |
| Spirit level | Wire cutter /stripper | Terminal crimping tool | Electrical adhesive tape | |
|  |  |  |  | |

2.3 Wiring Specifications and Circuit Breaker Selection

The wiring and installation must comply with requirements of the national and local electrical codes. The wiring specifications and circuit breakers are recommended as follows:

- Specifications of the AC input and output wire diameter and circuit breaker are as follows:

| Device Model | Recommended wire size of AC input/output | Maximum working current | Recommended model of the air switch or circuit breaker |
|---------------|--|-------------------------|--|
| FSA-3-4K1P-BL | 5.26mm ² /10AWG | 25A | 2P-32A |

- Specifications of the PV input wire diameter and circuit breaker are as follows:

| Device Model | Recommended wire size of PV input | Maximum working current | Recommended model of the air switch or circuit breaker |
|---------------|-----------------------------------|-------------------------|--|
| FSA-3-4K1P-BL | 5~8mm ² /8~10AWG | 18A | 2P-25A |

- Specifications of the battery input wire diameter and circuit breaker are as follows:

| Device Model | Recommended wire size of BAT input | Maximum working current | Recommended model of the air switch or circuit breaker |
|---------------|------------------------------------|-------------------------|--|
| FSA-3-4K1P-BL | 33mm ² /2AWG | 137A | 2P-180A |

- Specification of the shell earth wire is as follows:

| Device Model | Recommended size of the earth wire |
|---------------|------------------------------------|
| FSA-3-4K1P-BL | 4-6mm ² /10-12AWG |

Notes:

- The wire diameters are for reference only. If the distance between the PV array and the device or between the device and the battery is long, the thicker wire can reduce the voltage drop to improve the system efficiency.
- The above wire diameters and circuit breakers are theoretically recommended. Please select the appropriate wire diameters and circuit breakers based on actual conditions.

2.4 Installation and Wiring

Warnings:

- There is unsafe voltage in the grid input and PV input. Please disconnect the circuit breaker or air switch before wiring.
- During the wiring process, please make sure the circuit breaker and air switch are disconnected in case of short circuit and the “+” and “-” polarities on each port are correctly connected. The circuit breaker must be installed on the battery port.

Installation and wiring steps are as follows:

Step 1:

Reserve a gap of 500 mm above and below the inverter and a gap of 200 mm on the left and right on an appropriate wall to ensure ventilation and heat dissipation. Unpack and take out the inverter, disassemble the terminal cover by removing the screws, and fix the inverter on the wall with three screws. As shown in the figure below, fix the device through holes 1 and 2 with M6*80 expansion bolts, and through hole 3 with M4 or M5 screws.

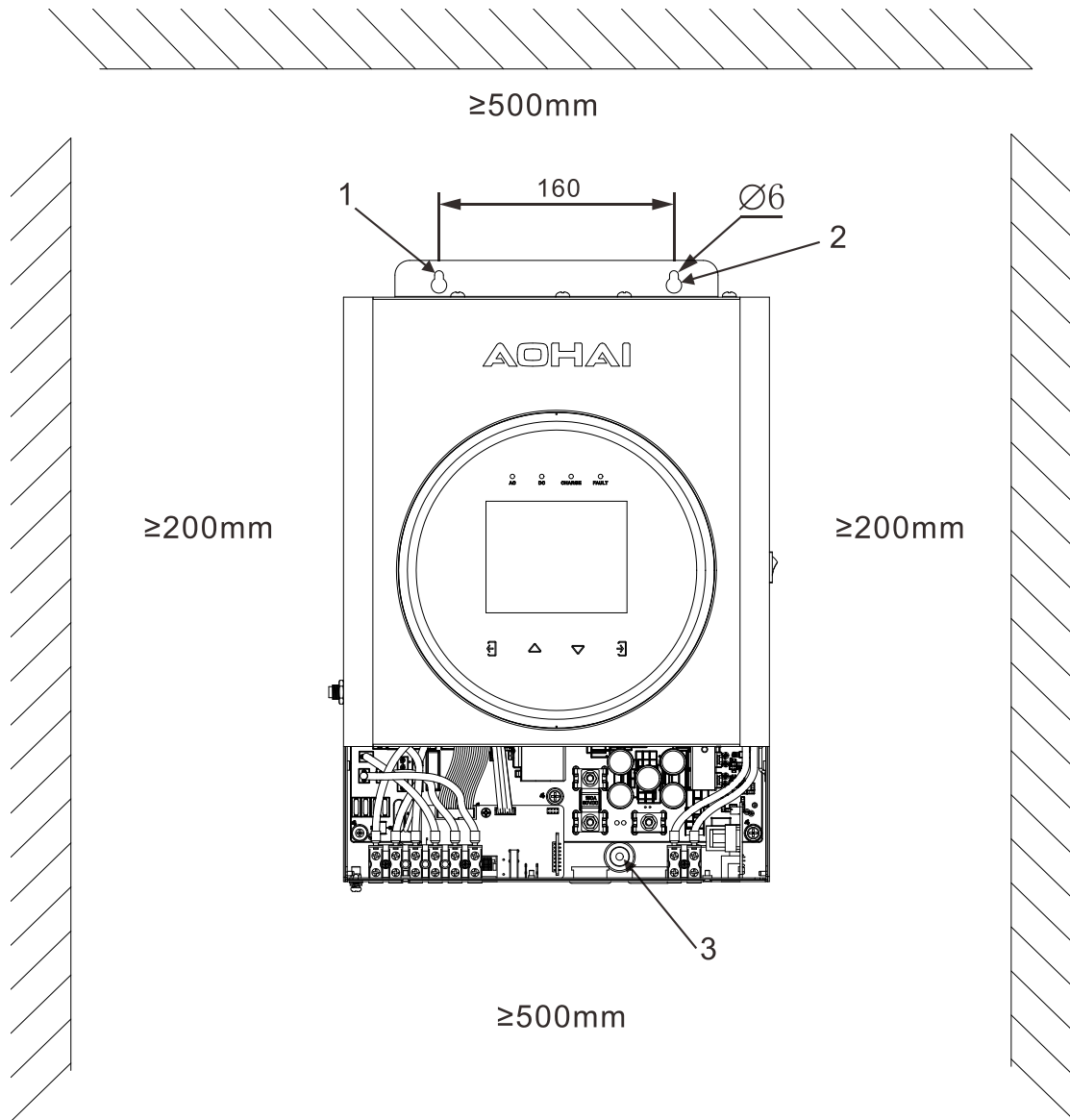

Step 2: Wiring

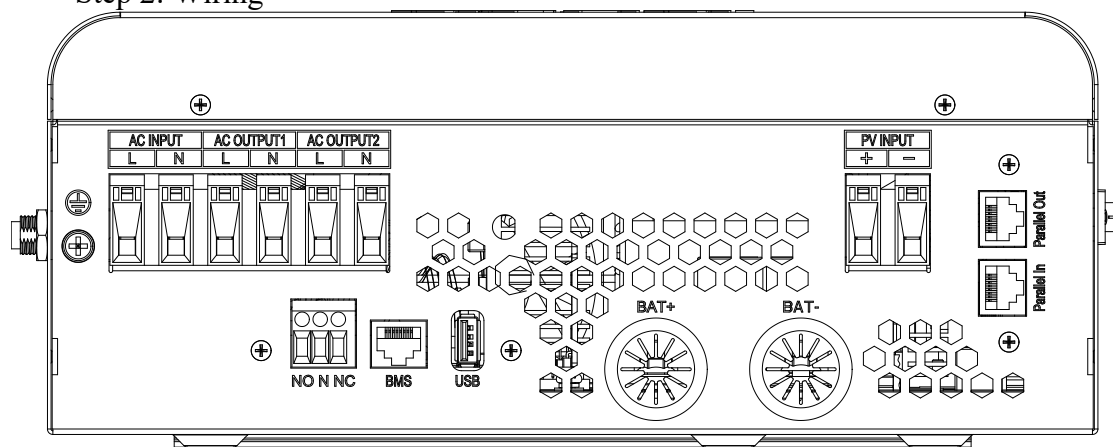

Bottom view

Please follow the steps below to perform the wiring. In order to ensure safe operation and comply with regulations, please install a circuit breaker and disconnect the circuit breaker before wiring.

(1) Connect the battery

Before wiring, disconnect the external circuit breaker and check whether the cables used are thick enough. Please refer to “2.2 Wiring Specifications and Circuit Breaker Selection.” The BAT cables must be connected to the device with an O-type terminal with a recommended internal diameter of 8mm. The O-type terminal must clamp the BAT cables tightly to prevent excessive heat caused by excessive contact impedance;

Insert BAT+/BAT- cables as indicated on the label, and fix them with the M8 flange nut. The torque is 20 kgf.cm. As shown in the figure below, “BAT+” represents the battery anode, and “BAT-” the battery cathode.

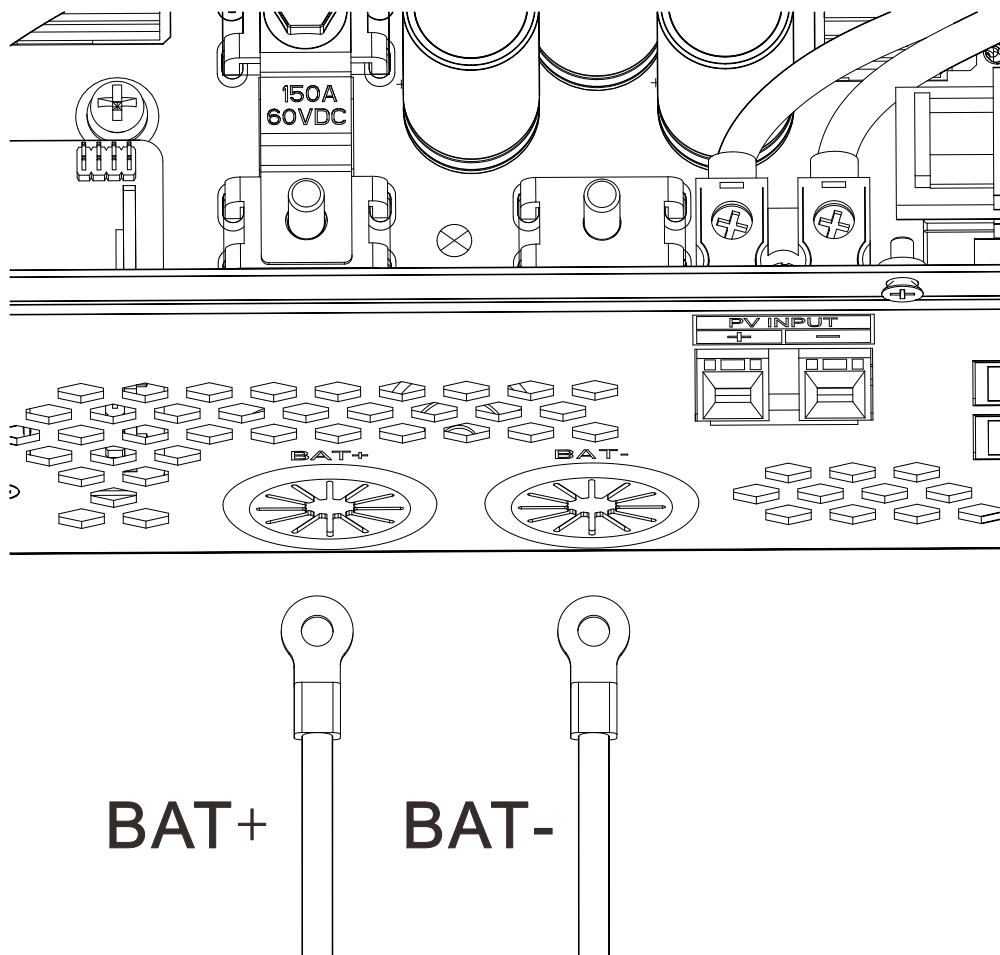

(2) Connect PV cables

Before wiring, please disconnect the external circuit breaker and check whether the cables used are thick enough. Please refer to “2.2 Wiring Specifications and

Circuit Breaker Selection.” Insert PV+/PV- cables as indicated on the label, and fix the terminals on the device with a slotted screwdriver. The torque is 12 kgf.cm. As shown in the figure below, “PV+” represents the positive PV input, and “PV-” the negative PV input.

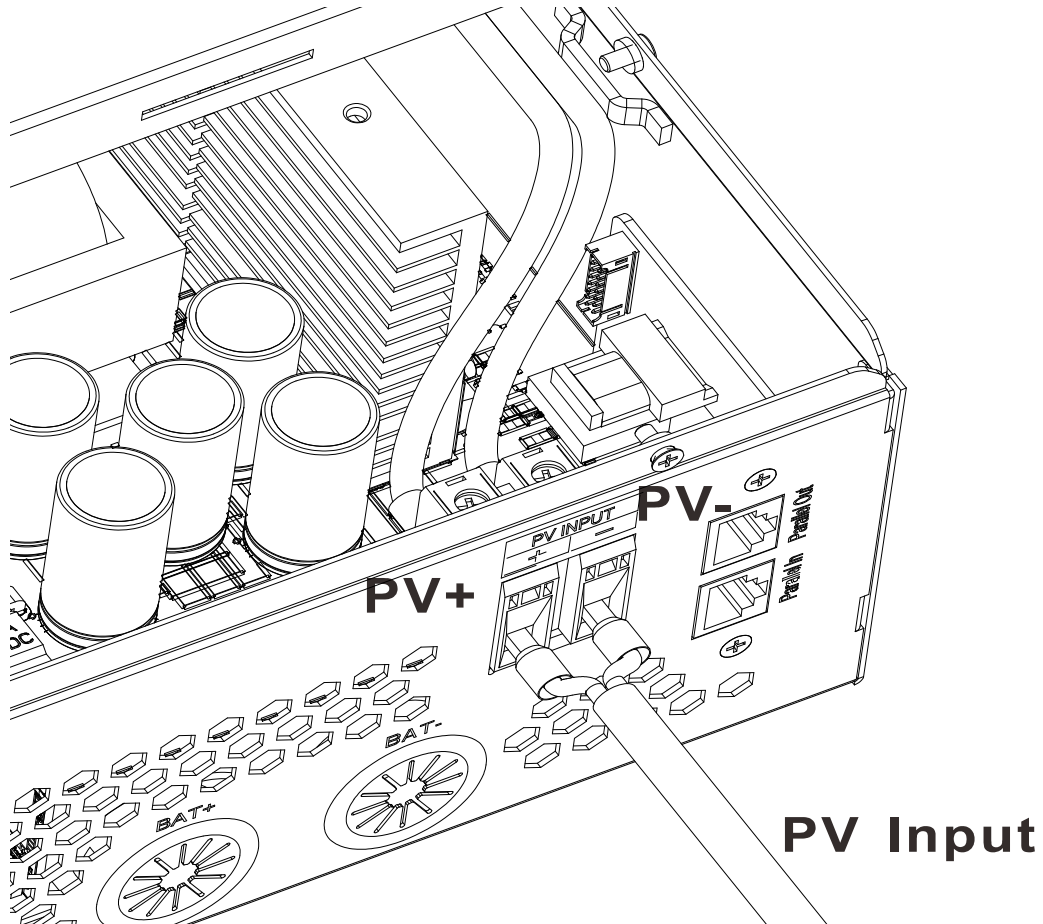

(3) Connect AC input

Before AC input wiring, please disconnect the external circuit breaker and check whether the cables used are thick enough. Please refer to “2.2 Wiring Specifications and Circuit Breaker Selection.”

Insert AC output cables as indicated on the label, and fix the terminals on the device with a slotted screwdriver. The torque is 12 kgf.cm. As shown in the figure below, “L” represents the live wire, “N” the neutral wire, and “PE” the protective earth wire.

(4) Connect AC output

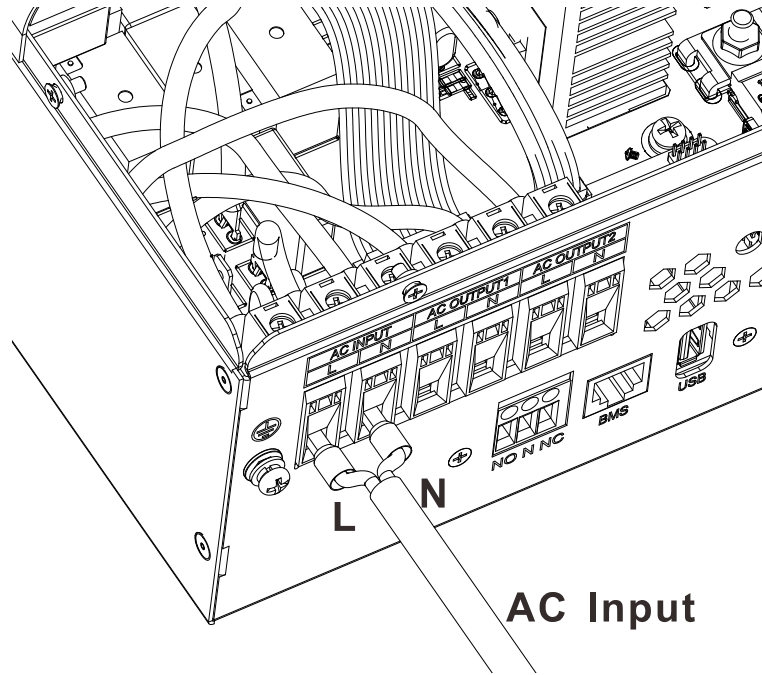

AC Input

The inverter has duplex output ports with “Output 1” being the primary load output port and “Output 2” the secondary load output port.

Before AC output wiring, please disconnect the external circuit breaker and check whether the cables used are thick enough. Please refer to “2.2 Wiring Specifications and Circuit Breaker Selection.”

Insert AC output cables as indicated on the label, and fix the terminals on the device with a slotted screwdriver. The torque is 12 kgf.cm. As shown in the figure below, “L” represents the live wire, “N” the neutral wire, and “PE” the protective earth wire. Please note that the two outputs share the same earth wire port.

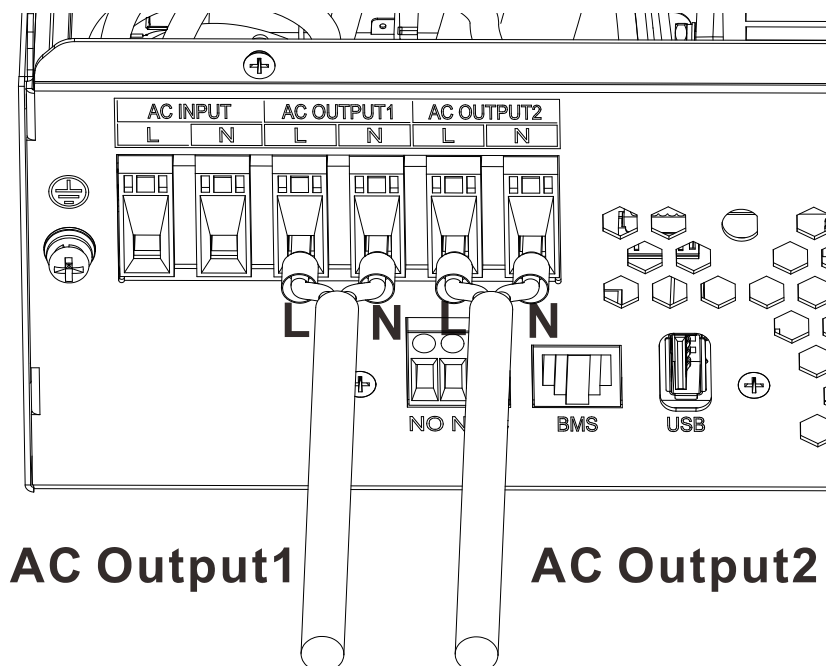

AC Output1

AC Output2

(5) Shell earthing

Please note an additional earthing point on the shell. Clamp the cable with the RNBL5-4 OT terminal and lock it in the position indicated in the figure below. For cable specifications, please refer to the “2.2 Wiring Specifications and Circuit Breaker Selection.”

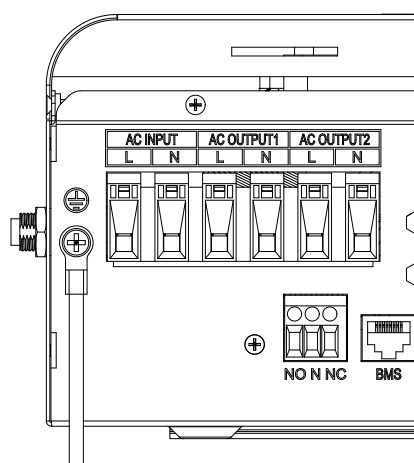

Step 3: Check whether the wiring is correct and firm, especially whether the battery input anode and cathode are correctly connected, whether positive and negative PV inputs are correctly connected, whether the AC input is incorrectly connected to the AC output, and whether the AC input is incorrectly connected to the input port of the diesel generator.

Step 4: Use a Phillips screwdriver to reinstall the terminal cover on the device. The torque is 7 kgf.cm.

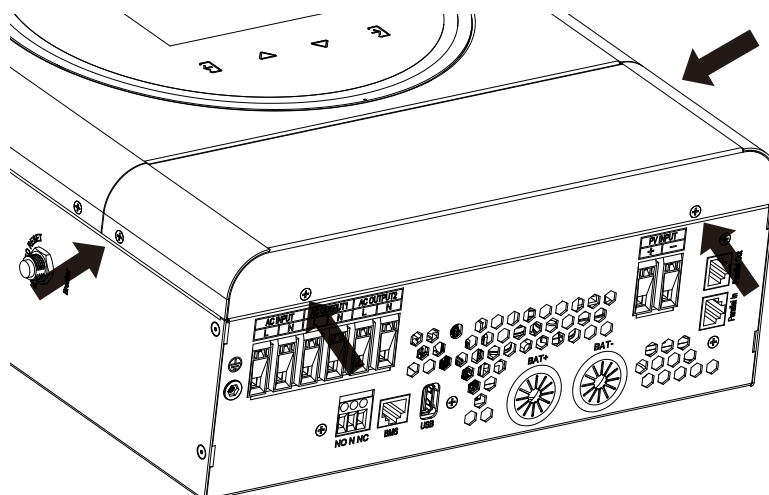

Step 5: Start the inverter

First, close the circuit breaker of the battery, and switch the inverter's rocker switch to the "ON" state. The blinking "AC" indicator indicates the normal operation of the inverter. Then, close the circuit breaker of the PV panel and the grid, and turn on the AC load after the AC output is normal. In this case, the inverter will work normally in accordance with the set mode.

Notes: If energy is supplied to different AC loads, it is recommended to turn on the load with a large impulse current first, and then turn on the load with a small impulse current after the load works stably, in order to avoid the protection action caused by a large transient impulse generated by turning on the load at the same time. If the inverter fails to work normally, and the LCD or indicator displays abnormality, please refer to Section 7 for troubleshooting.

2.5 Parallel Connection and Wiring (Only applicable to models with optional parallel function)

2.5.1 Introduction to Parallel Connection

1. The inverter supports upto 9 in parallel connection.
2. It is necessary to ensure that the parallel wiring is correct and firm with a gap of 300 mm between devices reserved in the use of the parallel function.

2.5.2 Guidance and Schematic Diagram of Single-phase Parallel Connection

1. AC IN wiring:

L,N and PE wires of all inverters must be connected to the same wires respectively. Make sure the connection is correct and the wire length and diameter are the same before power-on and startup to avoid abnormal output of the parallel system. Multiple different AC power sources are not allowed to ensure the consistency and uniqueness of the AC source.

2. AC OUT wiring

L,N and PE wires of all inverters must be connected to the same wires respectively. Make sure the connection is correct and the wire length and diameter are the same before power-on and startup to avoid abnormal output of the parallel system.

3. BAT wiring

All inverters must be connected to the same battery, BAT+ must be connected to BAT+, and BAT- must be connected to BAT-. Make sure the connection is correct

and the wire length and diameter are the same before power-on and startup to avoid abnormal output of the parallel system.

4. Parallel communication wiring

The parallel communication cable is a network cable, and each device is connected with one input cable and one output cable. The left network interface is used for output and the right network interface for input. The parallel communication cable shall be inserted in place to avoid system abnormality caused by poor communication.

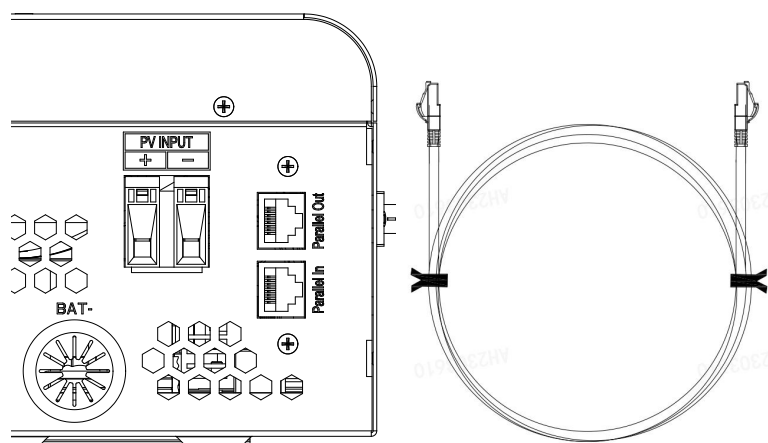

5. Note

Before and after connecting the system, please refer to the system wiring diagram in detail to ensure that all wiring is correct and reliable before power-on. If a new device needs to be connected after the system is properly wired, powered on and operates normally, please disconnect the battery input, PV input, AC input, AC output, and diesel generator input, and re-wire and incorporate into the system after all inverters are power-off detected by a multimeter.

6. Schematic diagram

In case of a single-phase parallel connection of multiple inverters, please conduct wiring according to the schematic diagram below:

- (1) Parallel connection of two inverters:

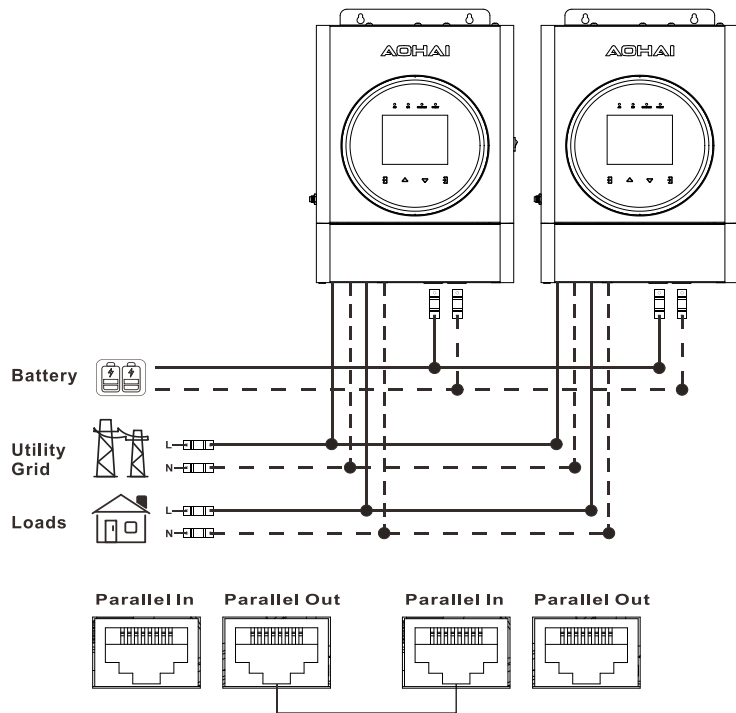

(2) Parallel connection of three inverters:

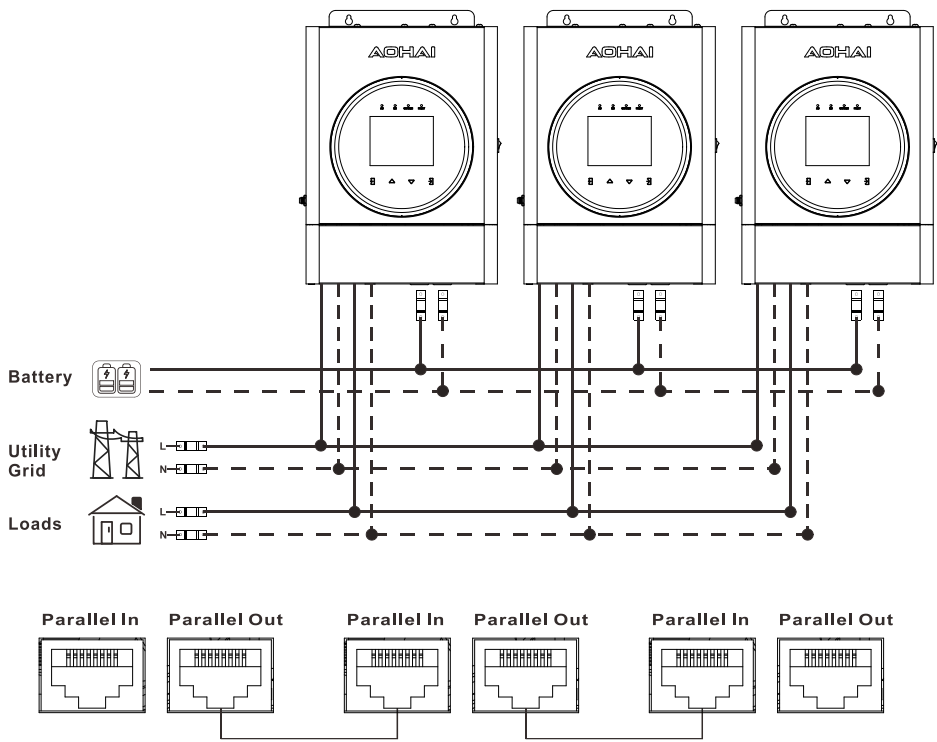

(3) Parallel connection of four inverters:

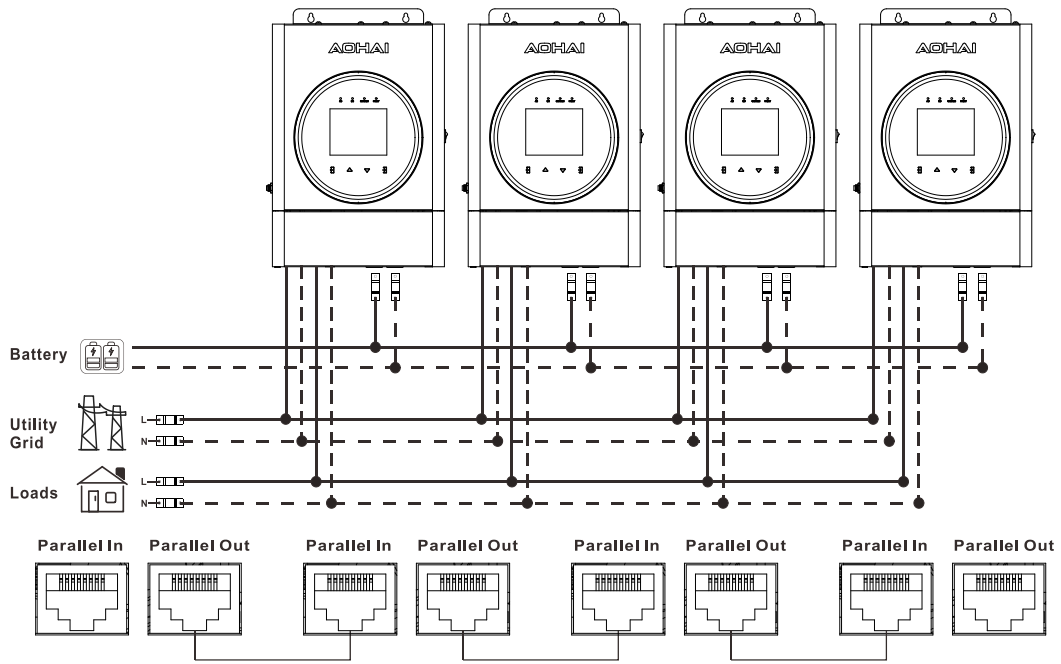

(4) Parallel connection of five inverters:

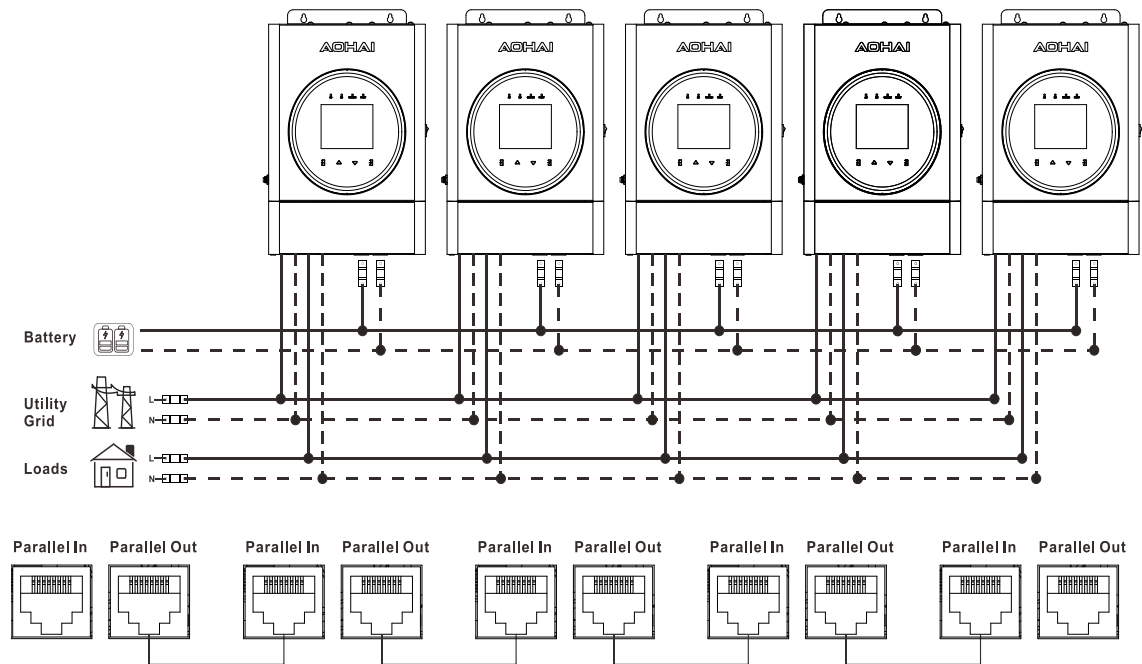

(5) Parallel connection of six inverters:

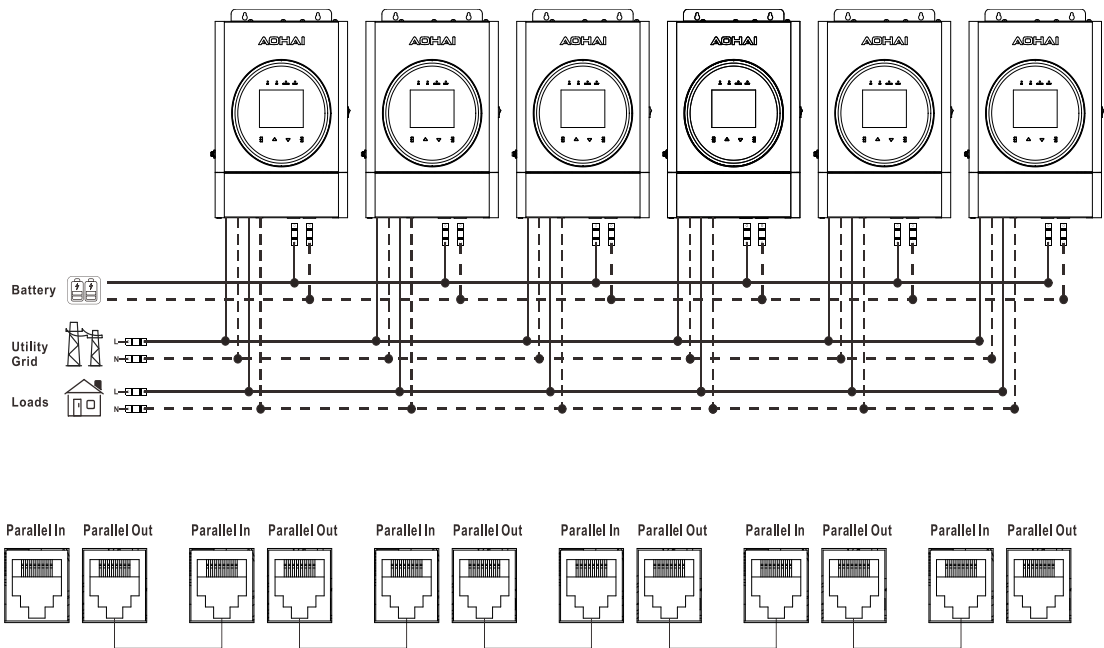

(6) Parallel connection of up to nine inverters, *ibid.*

2.5.3 Three single-phase parallel parameters setting and display

1. After wiring the three single-phase parallel machines as shown in the above figure, please note that the communication line must be plugged in (otherwise the machine will start working in stand-alone mode). When you power on for the first time, do not turn on the circuit breaker between the grid and the load end, and turn on the battery to power the machine.

2. Next, set the parameters of machine one through the screen. The parameter settings of machine one are as follows:

1) The 19th setting item on the screen is used to set the parallel CAN communication address, which is set to 0;



2) The 20th setting item on the screen is used to set the parallel mode, which is set to PAL single-phase parallel mode.

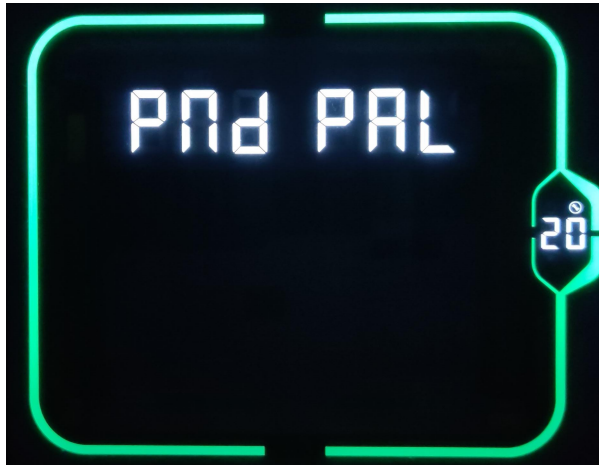

3) The 21st setting item on the screen is used to set the parallel device type, which is set to MAS host mode.



3. Next, set the parameters of machine 2 through the screen. The parameter settings of machine 2 are as follows:

1) The 19th setting item on the screen is used to set the parallel CAN communication address, set to 1;



2) The 20th setting item on the screen is used to set the parallel mode, which is set to PAL single-phase parallel mode.

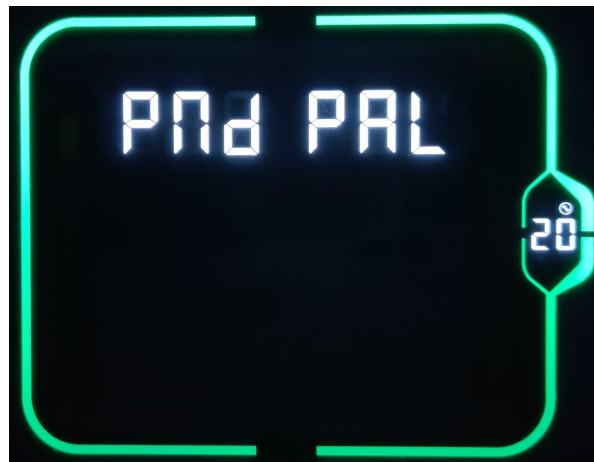

3) The 21st setting item on the screen is used to set the parallel device type, which is set to SAL slave mode.



4. Next, set the parameters of machine 3 through the screen. The parameter settings of machine 3 are as follows

1) The 19th setting item on the screen is used to set the parallel CAN communication address, which is set to 2;

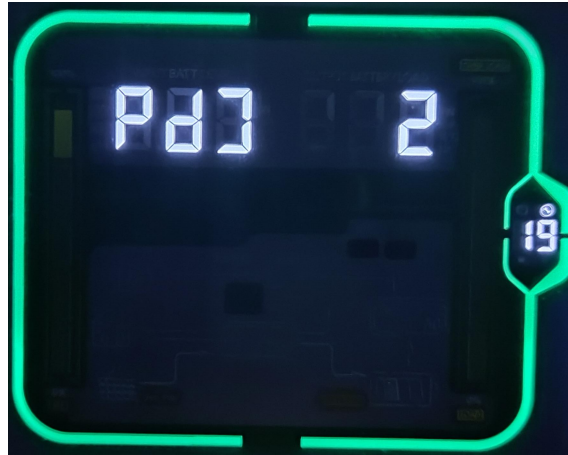

2) The 20th setting item on the screen is used to set the parallel mode, which is set to PAL single-phase parallel mode.



3) The 21st setting item on the screen is used to set the parallel device type, which is set to SAL slave mode.



5. After setting the above parameters, wait for 10 seconds, the parallel fault will disappear, and the system will enter the working state. Observe whether both machines enter the off-grid state. If both enter, it means the setting is OK.
6. Disconnect the battery at this time, wait for the machine to be powered off, then open the circuit breaker between the load end and the grid end, and then connect the battery, after which the system will enter the grid-connected working state.

2.5.4 Guidance and Schematic Diagram of Three-phase Parallel Connection

1. AC IN wiring:

N and PE wires of all inverters must be connected to identical wires. L wires of all devices in the same phase shall be connected together, but the L wires of AC input in different phases cannot be connected together. Other precautions shall be consistent with those of the single-phase parallel connection.

2. AC OUT wiring

N and PE wires of all inverters must be connected to identical wires. L wires of all devices in the same phase shall be connected together, but the L wires of AC output in different phases cannot be connected together. Other precautions shall be consistent with those of the single-phase parallel connection.

3. BAT wiring

All inverters must be connected to the same battery. BAT+ must be connected to BAT+, and BAT- must be connected to BAT-. Make sure the connection is correct and the wire length and diameter are the same before power-on and startup to avoid abnormal output of the parallel system.

4. Parallel communication cable

The parallel communication cable is a network cable, and each device is connected with one input cable and one output cable. The left network interface is used for output and the right network interface for input. The parallel communication cable shall be inserted in place to avoid system abnormality caused by poor communication.

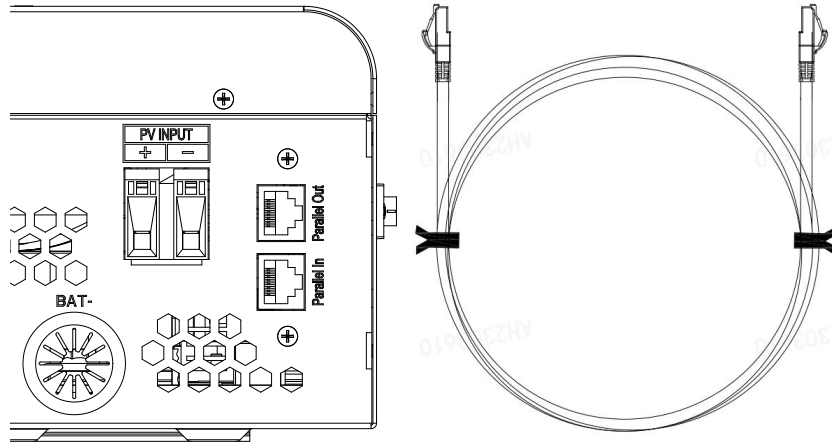

5. Note

Before and after connecting the system, please refer to the system wiring diagram in detail to ensure that all wiring is correct and reliable before power-on. If a new device needs to be connected after the system is properly wired, powered on and operates normally, please disconnect the battery input, PV input, AC input, AC output, and diesel generator input, and re-wire and incorporate into the system after all inverters are power-off detected by a multimeter.

6. Schematic diagram

In case of a three-phase parallel connection of multiple inverters, please conduct wiring according to the schematic diagram below:

(1) A three-phase system with three inverters

1+1+1 system:

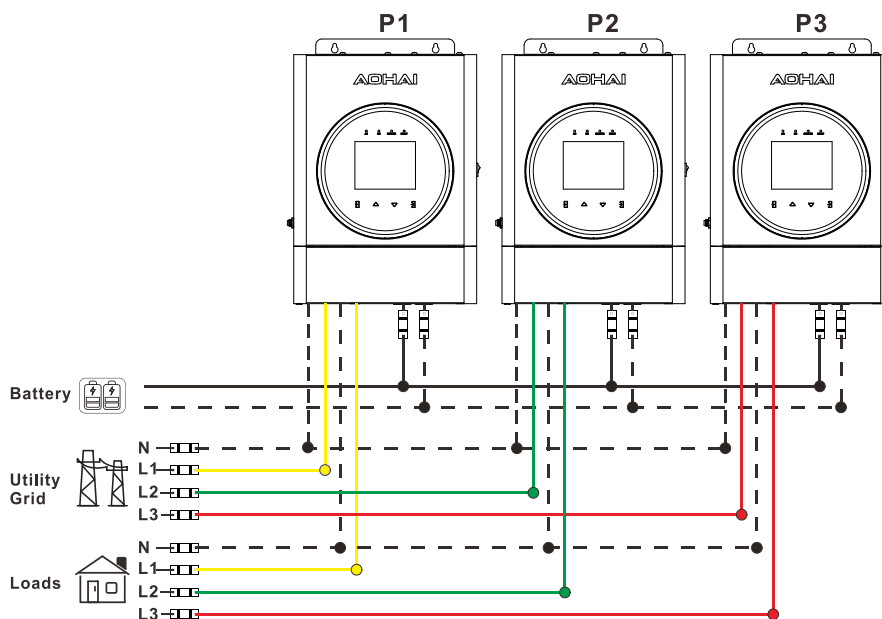

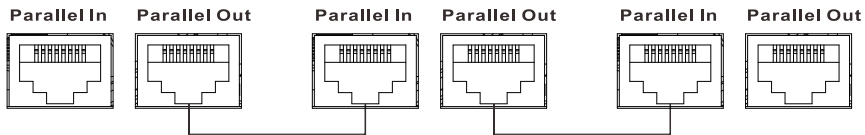

(2) A three-phase system with four inverters

2+1+1 system:

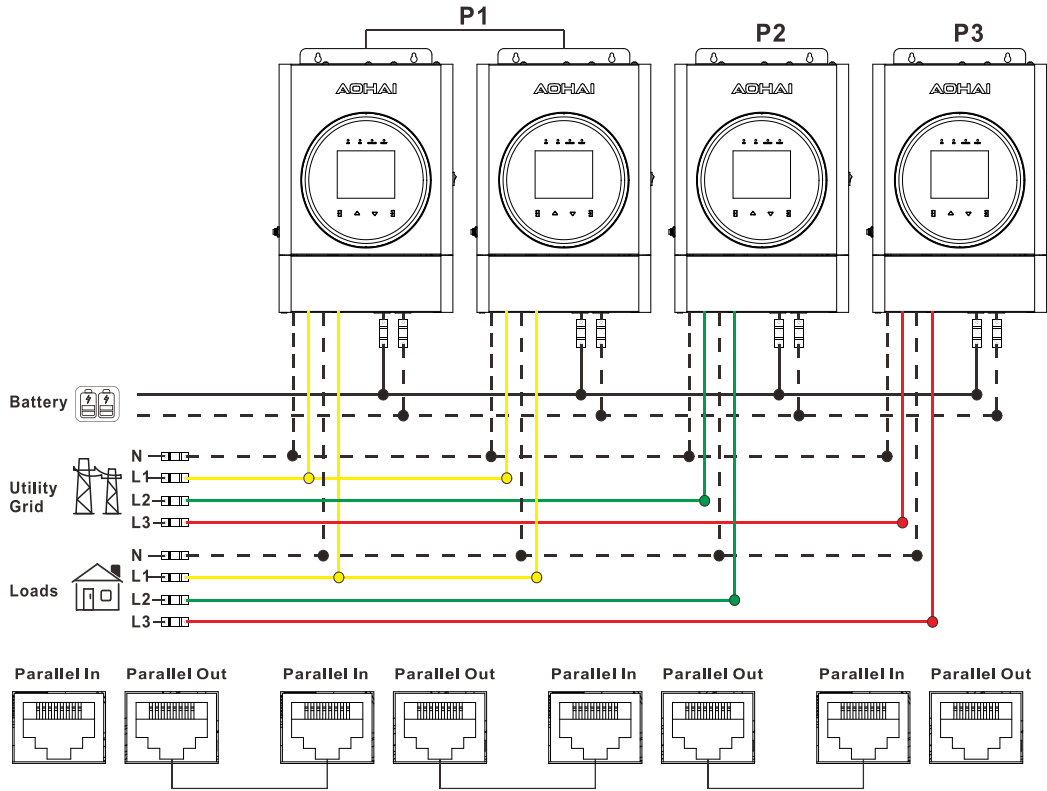

(3) A three-phase system with five inverters

2+2+1 system:

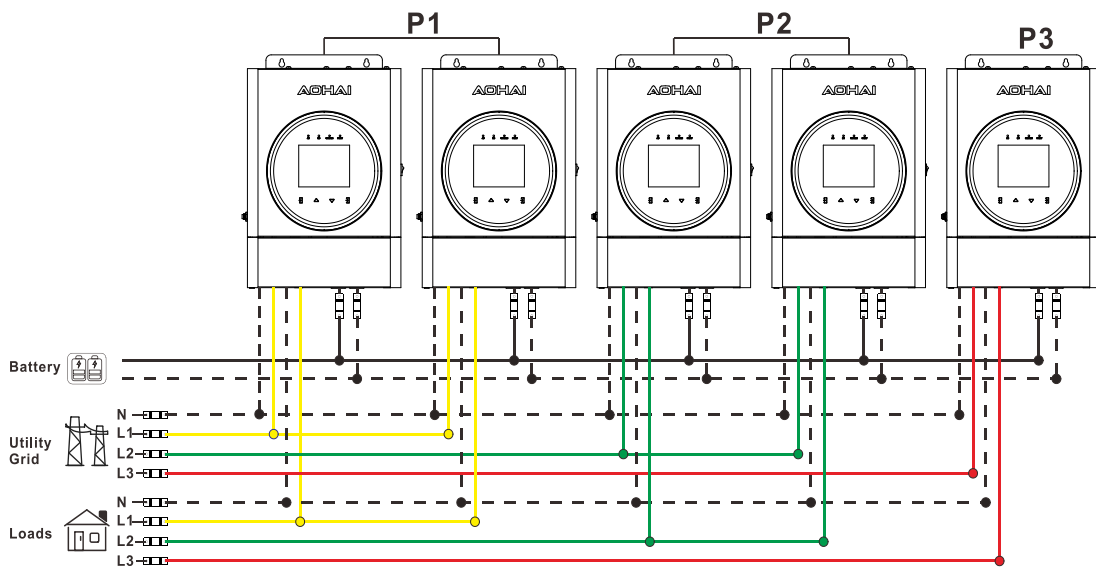

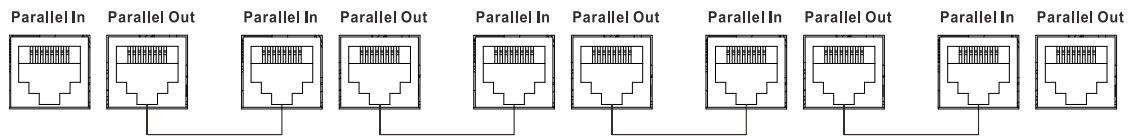

3+1+1 system:

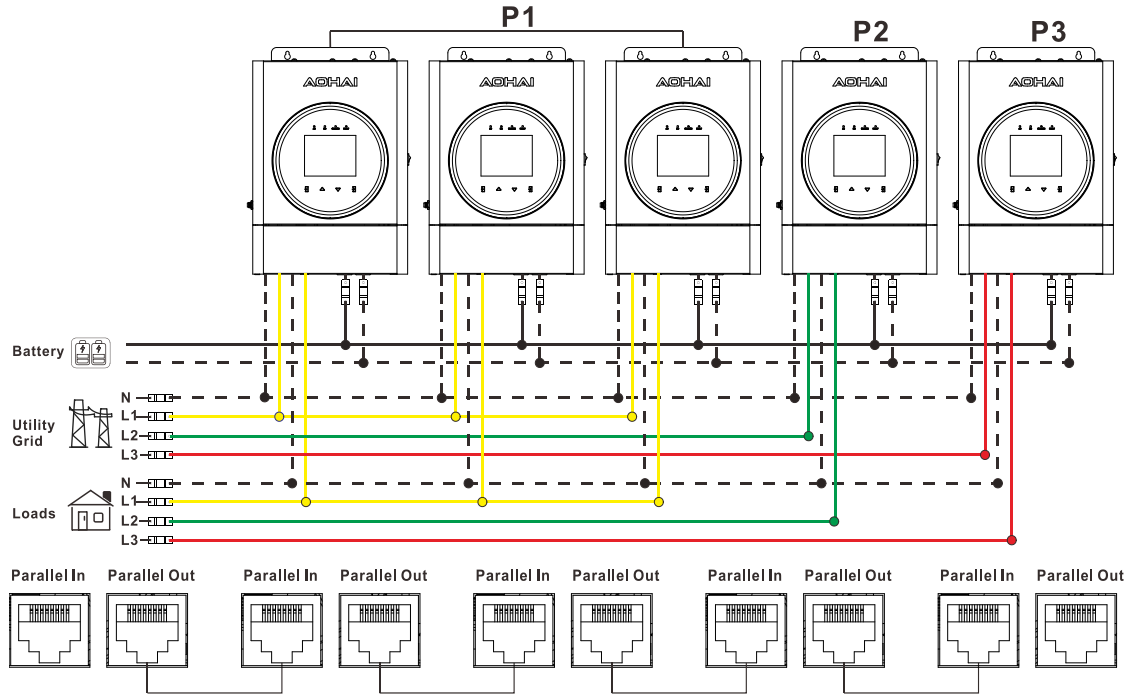

(3) A three-phase system with six inverters

2+2+2 system:

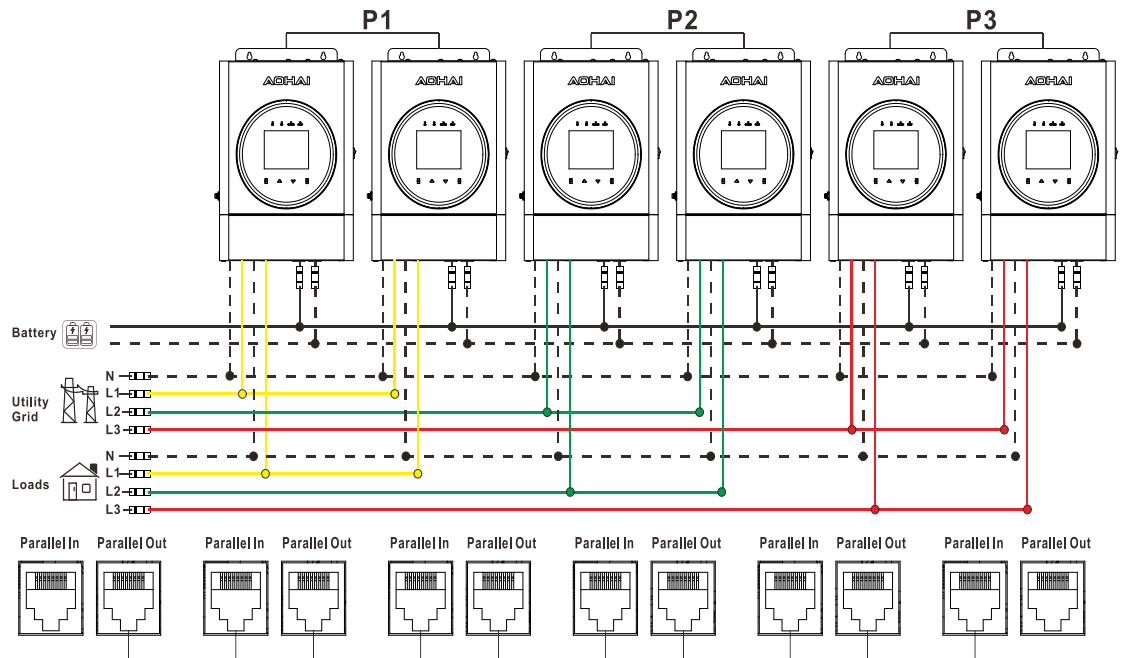

3+2+1 system:

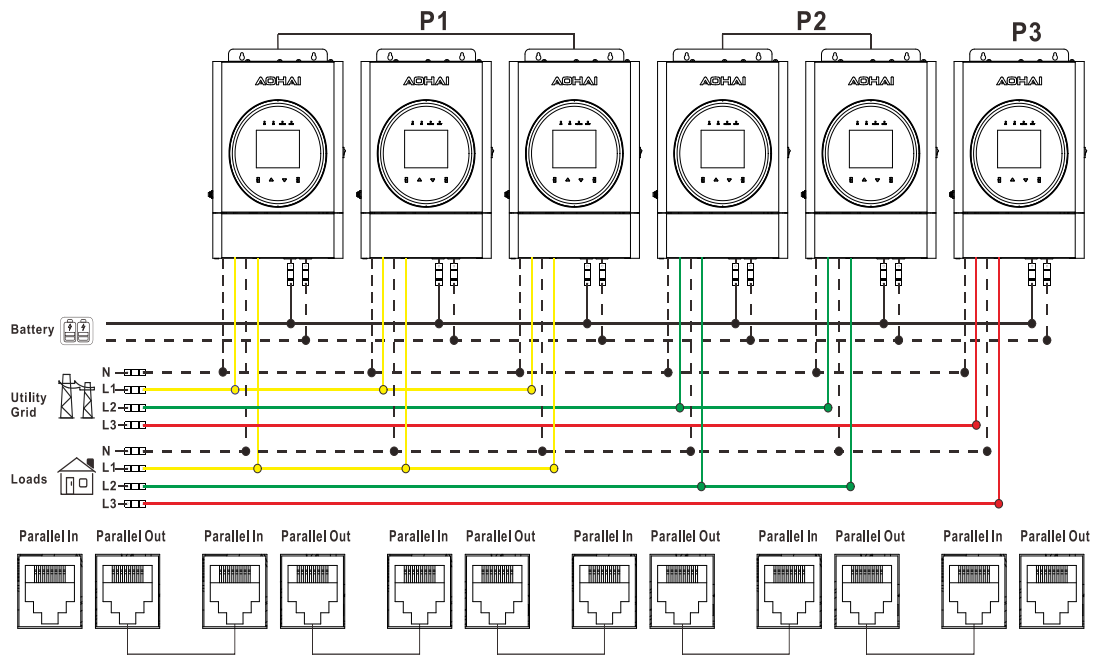

4+1+1 system:

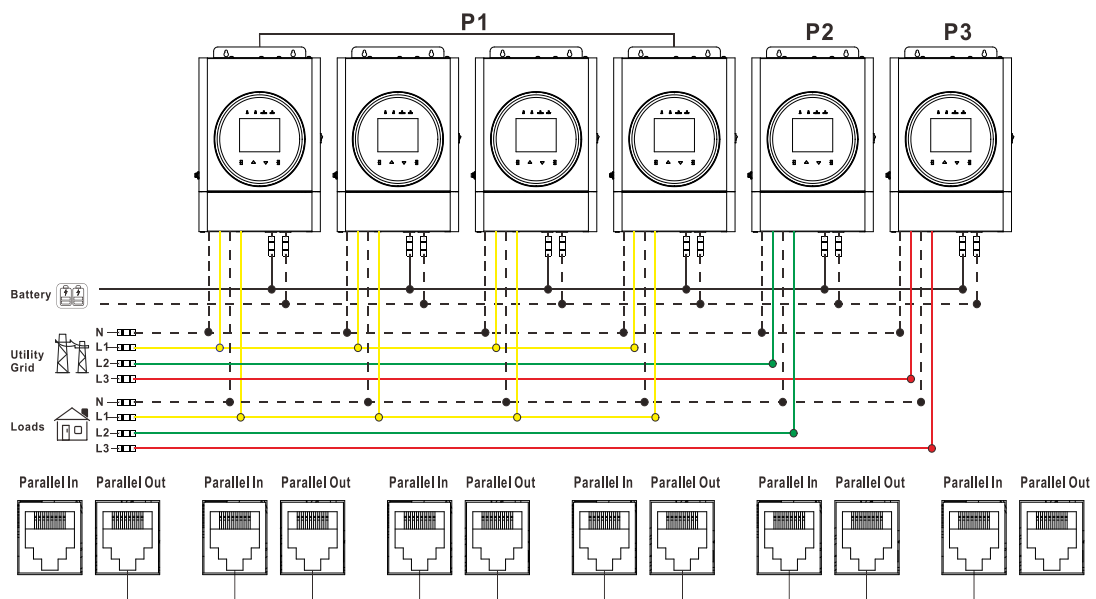

(4) Parallel connection of up to nine inverters, *ibid.*

Notes:

(1) It is necessary to check whether the wiring is correct according to the diagram above to avoid problems in the system before the inverter is powered on with its screen on.

(2) All connections shall be fixed firmly to avoid abnormal system operation caused by disconnected wires.

(3) When the AC output is wired to the load, the wiring shall be correctly connected according to the requirements for electrical equipment to avoid damages.

(4) After the system runs and the measured output voltage is correct, please turn on the load circuit breaker for power supply.

2.5.5 Three-phase system parallel parameter setting and example for three inverters

1. After wiring as shown in the figure above, please note that the communication line must be plugged in (otherwise the machine will start working in stand-alone mode). When you power on for the first time, do not turn on the circuit breaker between the grid and the load end, and turn on the battery to power the machine. 2. Next, set the parameters of machine one through the screen. The parameter settings of machine one are as follows:

2. Next, set the parameters of machine one through the screen. The parameter settings of machine one are as follows:

1) The 19th setting item on the screen is used to set the parallel CAN communication address, which is set to 0;



2) The 20th setting item on the screen is used to set the parallel mode, which is set to phase A in the three-phase parallel mode, 3P1.



3) The 21st setting item on the screen is used to set the parallel device type, which is set to MAS host mode.



3. Next, set the parameters of machine 2 through the screen. The parameter settings of machine 2 are as follows:

1) The 19th setting item on the screen is used to set the parallel CAN communication address, set to 1;



2) The 20th setting item on the screen is used to set the parallel mode, which is set to phase B in the three-phase parallel mode, 3P2.



3) The 21st setting item on the screen is used to set the parallel device type, which is set to SAL slave mode.



4. Next, set the parameters of machine 3 through the screen. The parameter settings of machine 3 are as follows

1) The 19th setting item on the screen is used to set the parallel CAN communication address, which is set to 2;



3) The 20th setting item on the screen is used to set the parallel mode, which is set to phase C in the three-phase parallel mode, 3P3.



3) The 21st setting item on the screen is used to set the parallel device type, which is set to SAL slave mode.



5. After setting the above parameters, wait for 10 seconds, the parallel fault will disappear, and the system will enter the working state. Observe whether both machines enter the off-grid state. If both enter, it means the setting is OK.
6. At this time, disconnect the battery, wait for the machine to be powered off, then open the circuit breaker at the load end and the grid end, and then connect the battery. After that, the system will enter the three-phase parallel working state.

3. Working Modes

3.1 Power Supply Modes

➤ PV power priority mode:

This mode prioritizes PV power for power supply to the load. When the PV power is unavailable, grid and battery will supply power to maximize the use of solar power generation and maintain the battery power. This working mode is suitable for areas with a relatively stable power grid. The priority of power supply realized at the load side is PV power -> Grid -> battery.

With PV energy input:

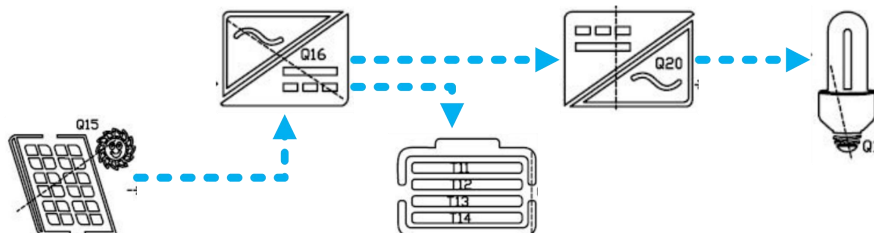

Without PV energy input:



➤ Grid priority mode

This mode prioritizes grid for power supply to the load. Battery inverter power supply will be applied only when the grid is unavailable, and grid charging and power supply will be applied when the grid is available. If there is PV power, PV power will charge the battery first, and the surplus energy and grid will be output to the load in a complementary way, maximizing the use of solar energy, reducing the use of grid, and keeping the battery power. This mode is suitable for areas with an unstable power grid. The priority of power supply realized at the load side is: Grid -> PV power -> battery.

With grid input:

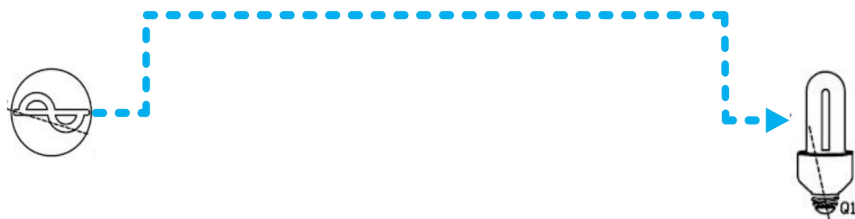

Without grid input:

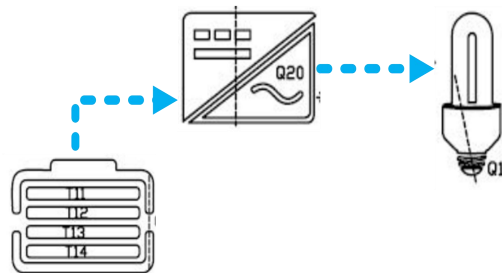

➤ Inverter priority mode:

In this mode, the grid will be applied for power supply only when the battery voltage is lower than the setting point (setting item 05), and the battery discharging mode will be applied when the battery charging voltage is higher than the setting point (setting item 06), so as to repeat the battery charging and discharging cycle. If there is PV power, PV power will maximize the use of solar energy according to PV energy and battery charging and discharging states. This mode is used in areas with a stable power grid. The priority of power supply at the load side is: PV power -> battery -> grid.

When the battery voltage is lower than the set point (05 setting item), switch to grid supply



The battery voltage is higher than the grid-to-battery voltage, switch to battery inverter

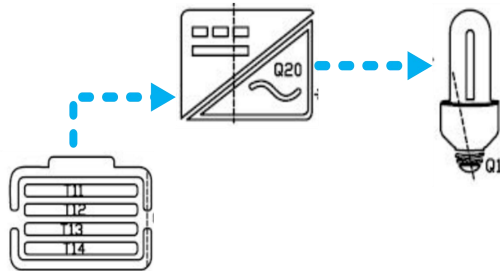

3.2 Charging Modes

➤ PV charging priority:

PV power gives priority to charging the battery, and the grid charging is only started when PV power does not meet the working conditions. This mode can make full use of solar energy to charge in the daytime and switches to grid at nighttime to keep the battery power, which is used in areas with a relatively stable power grid and relatively expensive electricity price.

With PV energy input:

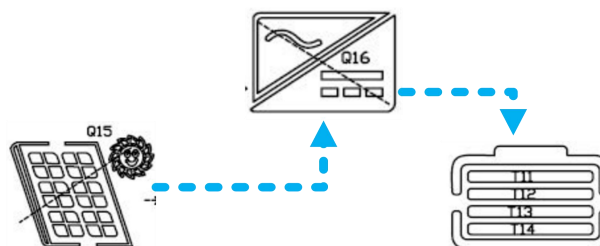

Without PV energy input:

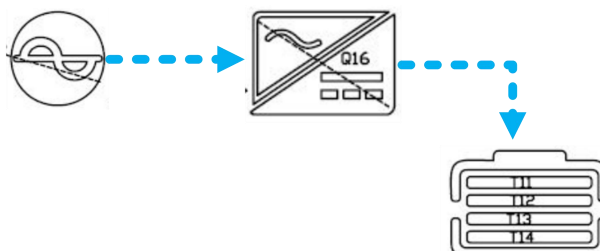

➤ Hybrid charging:

As for hybrid charging of PV energy and grid, PV energy charging is preferred with grid as a supplement when PV energy is insufficient. This mode mainly meets the requirement for maximum charging power with the fastest charging speed. It is suitable for areas with an unstable power grid, providing sufficient backup power supply.

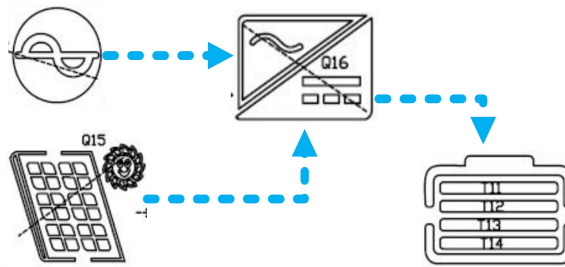

➤ PV charging mode only

Only the PV energy is used to charge the battery without grid. This mode is the most energy-saving one because the battery power comes from PV solar energy, which is usually used in areas with good lighting conditions.

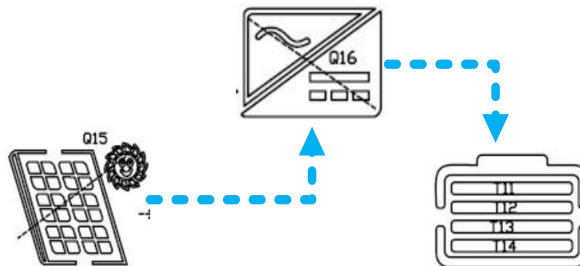

3.3 Battery Charging Parameters

➤ The charging curve of the lead-acid battery is shown in the figure below:

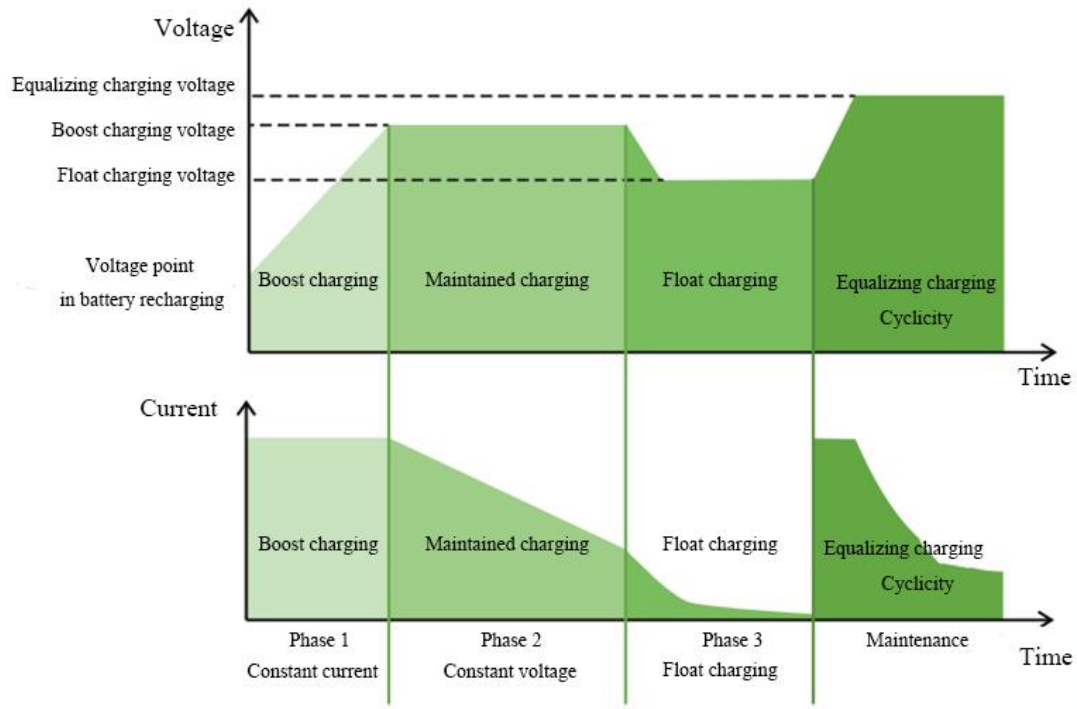

➤ The charging parameters of the lead-acid battery are shown in the table below:

| | |
|--|--------------------------------------|
| | Customized (USER) |
| Over-voltage disconnect threshold | 18~30V (Adjustable) |
| Recovery voltage in recharging after fully-charged | 26V (Adjustable) |
| Boost charging voltage | 18~30V (Adjustable) |
| Float charging voltage | 18~30V (Adjustable) |
| Equalizing charging voltage | 18~30V (Adjustable) |
| Under voltage alarm threshold | 18~30V (Adjustable) |
| Under voltage recovery threshold | Under voltage alarm threshold + 0.8V |
| Low-voltage disconnect threshold | 18~30V (Adjustable) |
| Low-voltage recovery | 26V (Adjustable) |
| Discharging limited voltage | 18~30V (Adjustable) |
| Over-discharge (detection) delay time | 1~30s (Adjustable) |
| Equalization duration | 0~600 min (Adjustable) |

| | | |
|---------------------|----------|----------------------------|
| Equalizing interval | charging | 0~250 days (Adjustable) |
| Boost duration | charging | 10~600 min (Adjustable) |

4. Operating Instructions for LCD Screen

4.1 Operation and Display Panel

- The operation and display panel include one display screen, four indicators, and four keys, as shown in the figure below.

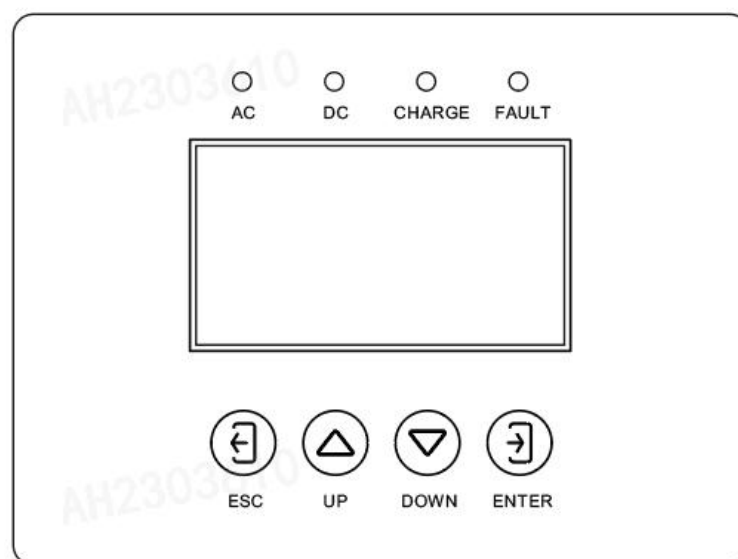



- Description of the indicators

| Indicator | Color | Description |
|-----------|--------------------------|-------------------------------------|
| AC | The green light is on | Grid charging or grid bypass output |
| | The green light flashes | Inverter output |
| DC | The yellow light is on | Battery discharging |
| CHARGE | The yellow light flashes | Fast charging |
| | The yellow light is on | Float charging |
| FAULT | The red light is on | Fault state |
| | The red light flashes | Firmware upgrade |

- Description of the Capacitive touch button

| Touch button | Description |
|--------------|--|
| | When out of the setting function, (on the Display menu or the Settings menu), the key is used for turning pages: click UP to turn the page up and click DOWN to turn the page down. When setting the parameters, the key is used to increase or decrease parameters; |
| | |

| | |
|---|--|
|  | On the Display menu, click to back to the first page. On the Settings menu, click to exit. |
|  | Press and hold it for 2s to enter the Settings menu and click to enter or confirm the options. |

➤ Introduction to Display Panel

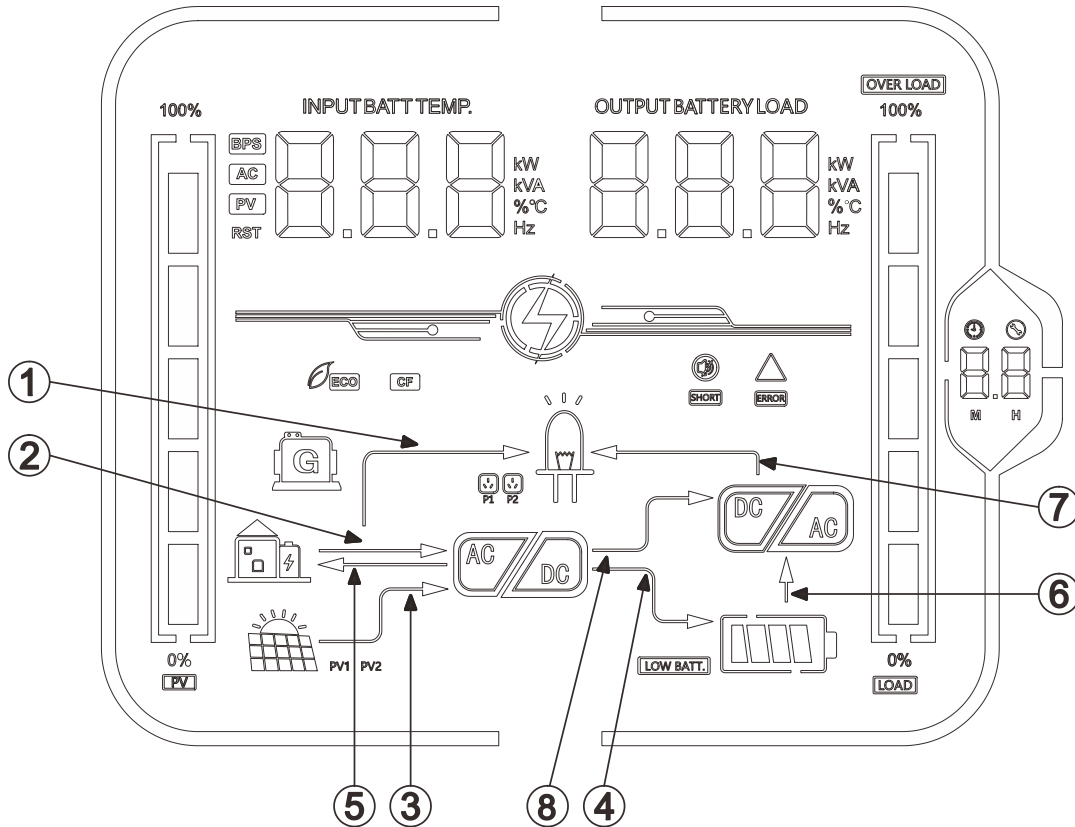











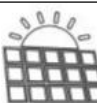

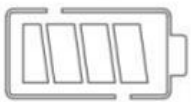
Arrow indication

| | | | |
|---|--|---|--|
| ① | Power grid to load | ② | Grid power supply to charging circuit |
| ③ | PV power supply to charging circuit | ④ | The charging circuit charges the battery |
| ⑤ | The inverter feeds electricity to the power grid | ⑥ | The battery supplies power to the inverter circuit |
| ⑦ | The inverter circuit supplies power to the load | ⑧ | The PV supplies power to the inverter circuit |

➤ Introduction to the icons on the display panel

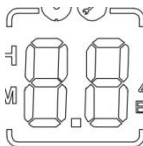
| Icon | Description | Icon | Description |
|------|-------------|------|-------------|
|------|-------------|------|-------------|

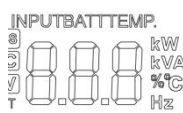
| | | | |
|--|--|---|---|
|  | The AC input port is connected to an AC input |  | The inverter circuit is working |
|  | PV connected to solar panels |  | AC output is in overload condition |
|  | Device connected to battery |  | AC output load percentage |
| LOW BATT. | The battery voltage is too low (battery SOC is less than 5%) |  | Buzzer is not enabled (mute) |
|  | AC/PV charging circuit is working |  | The device has an alarm event |
|  | AC output terminal has AC voltage output | ERROR | The device is in a fault state |
|  | The device is in setup mode | ECO | Energy saving mode icon |
|  | The parameter display on the far right of the screen, 1. In non-setting mode, it displays the current real-time parameter page number; 2. In setting mode, it displays the current setting page number | | |
| Parameters displayed on the left side of the screen: Equipment input parameters | | | |
|  | AC Input |  | PV Input |
| RST | The icon is not displayed |  | Displays battery voltage, total battery charging current, AC charging power, AC input voltage, AC input frequency, PV input voltage, internal heat sink temperature, software version |
| Parameters displayed on the right side of the screen: Device output parameters | | | |
| | | | Indicates output voltage, output current, output |

| | |
|--|---|
| | active power, output apparent power, battery discharge current, software version, alarm code, fault code; in setting mode, displays the setting parameters under the currently set parameter item code; |
|--|---|

➤ Real-time data check

Under normal conditions, there are 15 pages in the display screen. If no fault occurs, the parameter interface is in a polling state with the page automatically turned every three seconds, displaying information such as input and output voltage, input and output frequency, battery, PV voltage and current, load, software version and fault alarms. If any faults information, the red light will stay on constantly and needs to go to page 15 to check faults code.

Click UP or DOWN to scroll the display interface up or down, and stay on the current interface for 10s; click ESC to jump to the first page of real-time parameters; click ENTER to stay on the current display interface for 100s; press and hold ENTER for more than two seconds to enter the Settings interface. Information on the real-time parameter interface is as follows:

| Page | Parameter on the left of the screen | Parameter on the right of the screen |
|------|---------------------------------------|--------------------------------------|
| 1 | INPUT BATT V | OUTPUT LOAD V |
| 2 | / | PV OUTPUT KW |
| 3 | PV INPUT V | PV Output A |
| 4 | INPUT BATT A | OUTPUT BATT A |
| 5 | INPUT BATT KW | OUTPUT BATT KW |
| 6 | AC INPUT Hz | AC OUTPUT LOAD Hz |
| 7 | AC INPUT V | AC OUTPUT LOAD A |
| 8 | / | OUTPUT LOAD KVA |
| 9 | AC LOAD KW | INV OUTPUT LOAD KW |
| 10 | DSP software version | ARM software version |
| 11 | Model and battery voltage level (24V) | Output power level (4KW) |
| 12 | Model and PV voltage level (500V) | Model and PV current level (18A) |
| 13 | RS485 address | Phase sequence display |
| 14 | BMS | Alarm code |
| 15 | PAL | Fault code |

4.2 Parameter Settings

In the default interface, press and hold ENTER for more than two seconds to enter the Settings interface, and click ESC to exit to the real-time parameter display interface.

| Settings | Parameter | Option | Description |
|------------|---------------------------------|----------------|--|
| 【1】 | Power supply priority (WFM) | SOL | It indicates the PV power priority mode. When there is no PV input, the load automatically switches to the grid supply. |
| | | UTI (Default) | It indicates the grid priority mode. It switches to the battery inverter power supply only when there is no grid input. |
| | | SBU | It indicates the inverter power priority mode. It switches to the grid power supply only when the battery voltage is lower than the value set in parameter [04]; it switches to battery discharging and inverter power supply only when the battery is fully charged or higher than the value set in parameter [05]. |
| 【2】 | Off-grid output frequency (OPF) | 50Hz (Default) | Bypass adaptive function: when there is grid, it automatically adapts to the frequency of the first grid-on; When there is no grid, the output frequency can be set on the menu, and the default output of 230V AC inverter is 50 Hz. |
| | | 60Hz | |
| 【3】 | Input mode (GVR) | APL | A wide grid input voltage range for 230V device: 90~280VAC, applicable to household appliances. |
| | | UPS (Default) | A narrow grid input voltage range for 230V device: 170~265VAC, applicable to computers, etc. |
| 【4】 | Battery-to-grid voltage (BTG) | 23V (Default) | The default battery-to-grid supply voltage is 23V, with a setting range of 22V~26V and a step of 0.5V. When parameter [01] = SBU, the battery voltage is lower than the set value, and the output is switched from the inverter to the grid supply. This setting item is only applicable to lead-acid batteries. For BMS lithium battery settings, please refer to setting item [22]. |
| 【5】 | Grid-to-battery voltage (GTB) | 27V (Default) | The default grid-to-battery voltage is 27V, with a setting range of 24~29V and a step of 0.5V. When parameter [01] = SBU, the battery voltage is higher than the set value, and the output is switched from the grid to the inverter power supply. This setting item is only |

| | | | |
|------|---|------------------|--|
| | | | applicable to lead-acid batteries. For BMS lithium battery settings, please refer to setting item [22]. |
| 【6】 | Charging priority (CHM) | CSO | PV priority charging: The grid will be applied to charge the battery only when the PV power is unavailable. |
| | | SNU (Default) | Hybrid charging of PV and grid power: PV power charging is preferred with grid power as a supplement when PV energy is insufficient. When the PV energy is sufficient, grid stops charging. Note: Only when the grid bypass output is loaded, PV and grid charging can be applied simultaneously. When the inverter is working, the PV power will be applied to charge the battery. |
| | | OSO | PV charging only, without grid. |
| 【7】 | Maximum charging current of the battery (MCC) | 20A (Default) | The default maximum charging current of the battery is 20A, with a setting range of 1~120A and a step of 1A. |
| 【8】 | Lead-acid battery subtype (BTP) | USE | Customized battery: Users can set all battery parameters. |
| | | LIT | The setting enables the inverter to be compatible with non-communicating lithium batteries, as the inverter has lithium battery activation function. Under this mode, lithium battery charging and discharging are based on defined parameters. Users need to input charging and discharging parameters corresponding with battery information, otherwise the battery will be damaged. |
| 【9】 | Battery charging CV voltage (ICV) | 28.4V (Default) | The default CV voltage is 28.4V, with a setting range of 24~29.6V and a step of 0.4V. It is valid when the battery type is customized battery and lithium battery. |
| 【10】 | Maximum boost charging duration (ICT) | 120min (Default) | The default maximum boost charging duration is 120 min, with a setting range of 5~900 min, and a step of 5 min. It refers to the maximum charging duration when the voltage reaches the voltage set in parameter [11] during constant-voltage charging. |
| 【11】 | Float charging | 27.6V (Default) | The default float charging voltage is |

| | | | |
|------|---|---------------|---|
| | voltage (FLV) | | 27.6V, with a setting range of 24~29.2V and a step of 0.4V. |
| 【12】 | Battery under voltage alarm threshold (BUA) | 22V (Default) | The default under voltage alarm threshold of the battery is 22V, with a setting range of 20~25V, and a step of 0.4V. When the load is less than 50% of the rated power, if the battery voltage falls below this threshold, an under-voltage alarm will be triggered. When the load exceeds 50% of the rated power, if the low-voltage alarm point is 2V lower than the set value, and the inverter output will not be shut down. |
| 【13】 | LV Voltage (BLV) | 21V (Default) | The default LV voltage is 21V, with a setting range of 20~26V and a step of 0.4V. When the load is less than 50% of the rated power, if the battery voltage falls below this threshold, the inverter output will shut down immediately. When the load is higher than the rated power, if the battery voltage is 1V lower than the set value, the inverter output will be shut down immediately. It is valid when the battery type is customized battery and lithium battery. |
| 【14】 | Energy-saving mode enabled (ESM) | DIS (Default) | Energy-saving mode is prohibited |
| | | ENA | After the mode is enabled, if the inverter output load is empty or less than 50W, turn off the output after the inverter output is delayed for a period. When the load is greater than 50W, the inverter starts automatically. |
| 【15】 | Overload Auto Restart (OLR) | DIS | When overload auto restart is prohibited, if overload occurs, turn off the output, and the device will never restart. |
| | | ENA (Default) | When overload auto restart is enabled, if overload occurs, turn off the output, and the first restoration takes 30 seconds, the second restoration takes 30 seconds, and the third restoration takes 1 hour.. |
| 【16】 | Over-temperature restart enabled (OTR) | DIS | When over-temperature auto restart is prohibited, if over-temperature occurs, turn off the output machine and the inverter output will not |

| | | | |
|------|---|---------------|--|
| | | | restart. |
| | | ENA (Default) | When over-temperature auto restart is enabled, if over-temperature occurs, turn off the output, and the AC inverter output will be restarted after the temperature drops. |
| 【17】 | Buzzer switch (BAL) | DIS | The buzzer alarm is prohibited with a muse mode. |
| | | ENA (Default) | The buzzer alarm is enabled. |
| 【18】 | Limit current of AC charging (ACM) | 60A (Default) | The default limited current is 60A for AC battery charging, with a setting range of 1~100A and a step of 1A. |
| 【19】 | Device communication address (PDI) | 0 (Default) | The parallel mode of the device shall be set with a range of 0~9. |
| 【20】 | Parallel mode (only available under the standby mode) (PMD) | SIG (Default) | Settings for the standalone use of the device. |
| | | PAL | Settings for the single-phase parallel use of the device. |
| | | 3P1/3P2/3P3 | Settings for the three-phase parallel use. All machine screens connected to P1 should be set to “3P1”; All machine screens connected to P2 should be set to “3P2”; All machine screens connected to P3 should be set to “3P3”; Suppose that when the output voltage in the setting [26] is 230V AC (the model supporting parallel connection): In this case, the voltage phases between (P1-P2, P1-P3, P2-P3) are different by 120 degrees, and the voltage between the live wire L1 of P1 phase and the live wire L2 of P2 phase is $230 \times 1.732 = 398V$ AC. Likewise, the wire voltage between L1-L3 and L2-L3 is 398V AC; The voltage between L1-N, L2-N and L3-N is 230V AC. |
| 【21】 | Type of parallel equipment(PDT) | MAS (Default) | Select the current device as the host. If the parallel mode setting is 3P1, this item will be automatically selected as the host type |
| | | SAL | Select the current device as the slave |
| 【22】 | BMS communication mode (BMS) | DIS (Default) | Do not select BMS communication. |
| | | CAN | Select CAN as BMS communication. |
| | | 485 | Select RS485 as BMS communication. |

| | | | |
|------|---|----------------|---|
| 【23】 | Battery communication protocol (BDS) | PYL (Default) | When setting [22] =CAN or 485, it is needed to select the corresponding lithium battery manufacturer/brand for communication. PYL=PYLONTECH |
| 【24】 | Low-voltage recovery threshold (LVR) | 26V (Default) | The default recovery threshold for low-voltage disconnection battery voltage is 26V, with a setting range of 25~29V and a step of 0.5V. When the inverter output is disconnected due to the battery's low voltage, the battery inverter AC output can be recovered when the battery voltage is higher than this set value. |
| 【25】 | Battery recharging recovery threshold (BRC) | 26V (Default) | The default battery recharging recovery threshold is 26V, with a setting range of 25~28V and a step of 0.5V. After the battery is fully charged, the inverter charging stops, and the battery charging can be recovered when the battery voltage is lower than this voltage value. |
| 【26】 | Off-grid output voltage (GOV) | 230V (Default) | The default off-grid output voltage is 230V, with an optional setting of 200/208/220/230/240V. |
| 【27】 | Dual-load enabled (DLE) | DIS | This function is prohibited. |
| | | ENA (Default) | AC Output1 connects to a critical load, and AC Output2 connects to a non-critical load (usually a high-power load). When the battery voltage is lower than the value set in [28], AC Output2 will be disconnected. |
| 【28】 | Non-critical load disconnection battery voltage (LDV) | 23V (Default) | The default non-critical load disconnection battery voltage is 46V, with a setting range of 21~27V and a step of 0.5V. |
| 【29】 | Battery low-voltage shutdown voltage (delayed shutdown) (BDL) | 20V (Default) | The default battery low-voltage shutdown voltage is 20V, with a setting range of 20~24V and a step of 0.4V. When the battery voltage is lower than the threshold and the parameter 42 is triggered, the inverter output will be shut down. It is valid when the battery type is customized batteries and lithium batteries. |
| 【30】 | On-grid discharge cutoff SOC (GSD) | 50 (Default) | The default On-grid discharge cutoff SOC is 50, with a setting range of |

| | | | |
|------|--|---------------|--|
| | | | 10~ 90 and a step of 10. Lithium batteries end discharge to recover SOC under hybrid loads of the grid and the battery.Only valid for BMS communication lithium batteries. |
| 【31】 | On-grid end-of-discharge recovery SOC (GRD) | 90 (Default) | The default On-grid end-of-discharge recovery SOC is 90, with a setting range of 20~100 and a step of 10. Lithium batteries end discharge to recover SOC under hybrid loads of the grid and the battery.Only valid for BMS communication lithium batteries. |
| 【32】 | Off-grid discharge cutoff SOC (OSD) | 20 (Default) | The default off-grid discharge cutoff SOC is 20, with a setting range of 5~ 90 and a step of 5. End-of-discharge SOC of lithium batteries under disconnected grid-tied relay and loaded battery.Only valid for BMS communication lithium batteries. |
| 【33】 | Off-grid end-of-discharge recovery SOC (ORD) | 30 (Default) | The default off-grid end-of-discharge recovery SOC is 30, with a setting range of 10~ 100 and a step of 10. End-of-discharge SOC of lithium batteries under disconnected grid-tied relay and loaded battery.Only valid for BMS communication lithium batteries. |
| 【34】 | Bluetooth enabled (BTE) | DIS | This function is prohibited. |
| | | ENA (Default) | Turn on Bluetooth. |
| 【35】 | Anti reverse mains power setting(GPC) | 40(Default) | Set the input power from the Grid under grid connected conditions, The larger the setting value, the better the anti reverse effect. Range 0-200W, step 5. |
| 【36】 | Grid Feeding enablement(GFE) | DIS(Default) | This function is prohibited. |
| | | ENA | When the input power priority is in the mains priority mode, the inverter is enabled to feed power to the grid, and excess photovoltaic energy can be fed into the grid after inversion.This item requires password (618) verification to allow setting. |
| 【37】 | Charging cut-off SOC(CES) | 100(Default) | When the lithium battery reaches the set SOC value during charging, it stops charging and is only effective for BMS communication lithium battery. |

| | | | |
|------|-------------------------------|-----|---|
| 【38】 | Restore factory settings(FRS) | YES | After setting this option, you need to enter a password (618) for verification. Once verified, the system settings parameters will be restored to their factory default values. After the restoration is complete, the system will restart. |
|------|-------------------------------|-----|---|

5. Other Functions

5.1 RS485 Communication Function

This port integrates RS485 and CAN:

- RS485 communicates with lithium battery BMS (customized);
- CAN communicates with lithium battery BMS (customized).

Network port pins are defined as follows:



| | | | |
|---|-------|---|---------|
| 1 | 485-B | 5 | CANL |
| 2 | 485-A | 6 | NC |
| 3 | GND | 7 | GND |
| 4 | CANH | 8 | BAT_NTC |

5.2 USB Port Function

The USB port can connect to the USB disk to upgrade the firmware of the machine. The steps are as follows:

- Step 1: Make a burning USB drive
 1. Make sure the USB drive format is FAT32;

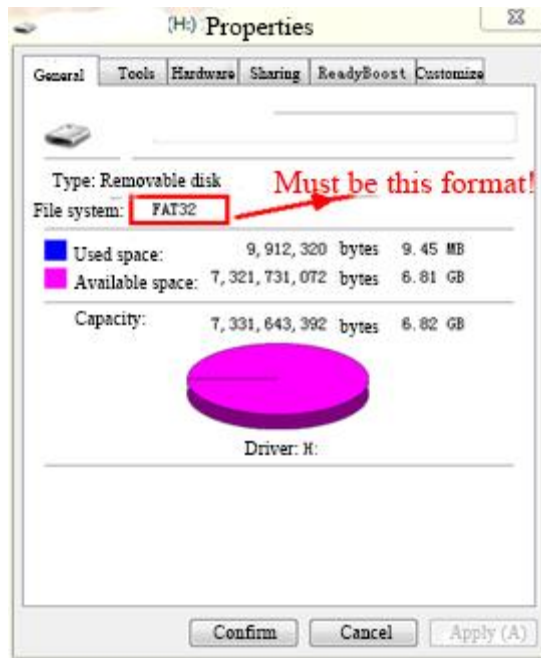

2. All files provided by our company are in the root directory of the USB drive.

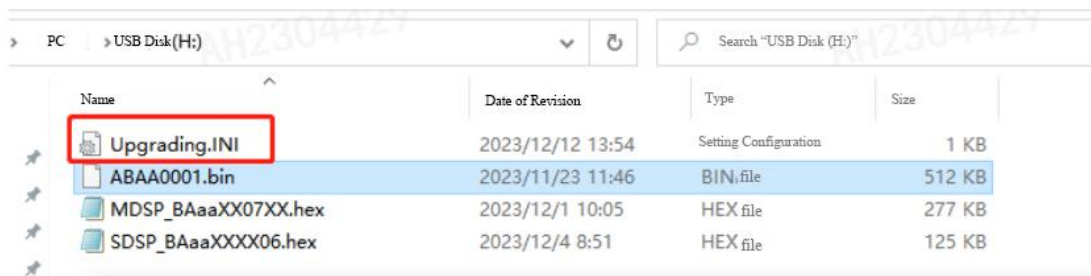

3. Check if the ini configuration file name is "Upgrading". If not, you need to update the file name to "Upgrading"



➤ Step 2: Burning

Insert the produced USB drive into the USB port for automatic burning. The red light flashes at an interval of 100ms to check whether burning is underway. HEX burning is about 1 min, and BIN file burning is about 15s. Burning multiple files has an interval of about 5s.

5.3 Dry Contact Function

This dry contact can control the ON/OFF of the diesel generator to charge the battery. ① Normally, the NC-N point is closed and the NO-N point is open; ② When the battery voltage reaches the low-voltage disconnection threshold, the relay

coil is energized, and the NO-N point is closed while the NC-N point is open. At this point, the NO-N point can drive resistive loads: 125VAC/1A, 230VAC/1A, and 30VDC/1A. The dry contact interfaces are shown in the figure below.

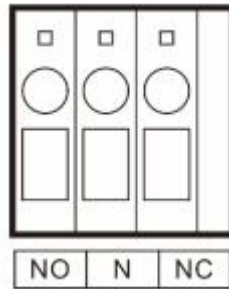

5.4 Wi-Fi Wireless Communication Function

The internal Wi-Fi of the energy storage inverter can be connected to the local router. After the data is uploaded to the server, the user can view the operating parameters and device status anytime and anywhere via the mobile APP while completing some general settings of the inverter with the APP.

6. APP Instructions

1. Please scan the QR code with your mobile phone to download the APP and obtain the instructions.



Android

IOS



HaiPower manual

User manual

7. Protection

7.1 Error Code

Buzzer working logic:

- Alarm: The alarm indicator flashes, and the buzzer beeps once every 1s and lasts for 30s before it stops.
- Fault: The fault indicator code is on, and the buzzer stops after a 10-second beep.

| Error type | Error code | Error description |
|------------|----------------|---|
| Fault | 103 | Inverter DC offset is too high |
| | 105 | Bypass AC output is overloaded |
| | 200 | Off-grid output voltage is too low |
| | 201 | Off-grid output voltage is too high |
| | 202 | Off-grid output has a short circuit |
| | 203 | Off-grid output is overloaded |
| | 204 | Abnormal off-grid output DC component offset |
| | 301 | Battery open circuit |
| | 305 | Battery overvoltage |
| | 306 | Battery overcurrent |
| | 307 | Battery communication fault |
| | 308 | BMS fault |
| | 400 | PV overvoltage |
| | 403 | PV short circuit |
| | 404 | PV reverse connection |
| | 500 | Abnormal BUS voltage |
| | 501 | Abnormal BUS voltage sampling |
| | 502 | Abnormal communication in the device |
| | 505 | Abnormal connection of the temperature sensor |
| | 506 | Device over-temperature |
| 507 | Abnormal relay | |

| | | |
|-------|-----|---|
| | 509 | Anti-counter-current output timeout |
| | 510 | Mismatched software version |
| | 511 | Fan fault |
| | 513 | Parallel abnormality |
| Alarm | 103 | Grid unavailable |
| | 104 | Overrange voltage of grid |
| | 105 | Overrange frequency of grid |
| | 106 | No output voltage from the generator |
| | 107 | Overrange output voltage of the generator |
| | 108 | Overrange output frequency of the generator |
| | 302 | Low battery |
| | 304 | Abnormal BMS information |
| | 305 | Low battery voltage alarm |
| | 502 | Abnormal memory reading and writing |

7.2 Troubleshooting (partial)

| Fault Code | Fault Description | Troubleshooting |
|-------------------|-------------------------------|--|
| 202 | Off-grid output short circuit | Check whether the load end wiring is short-circuited. Restart the inverter after clearing the short circuit. |
| 203 | Off-grid output overload | Restart the inverter after reducing the electric equipment. |
| 301 | Battery open circuit | Check whether the battery circuit breaker is switched on and battery cables are connected. |
| 305 | Battery overvoltage | Check whether the battery voltage exceeds the protection value and discharge the battery until it is lower the overvoltage recovery value. |
| 306 | Battery overcurrent | Restart the inverter after reducing the electric equipment. |
| 308 | BMS fault | Check BMS fault information. |
| 400 | PV overvoltage | Use a multimeter to check whether the solar energy input voltage exceeds the maximum PV input voltage of the device. |
| 404 | PV reverse connection | Check whether the solar energy input wiring is reversed. |
| 506 | Device over-temperature | Check whether the heat dissipation hole of the device is blocked by foreign bodies. The device will return to normal operation after cooling down. |
| 511 | Fan fault | Check whether the fan is blocked by foreign bodies. |
| | No display on the screen | Check whether the device switch is ON and whether the battery and PV circuit breaker are switched on; Press any key on the screen to wake up the screen. |

8. System Maintenance

➤ In order to maintain the best performance of the inverter, it is recommended to check the following items three times a year:

① Make sure that the airflow around the inverter is not blocked and remove any dirt or debris from the air intake to ensure the intake air volume.

② Check the wires for electrical leakage caused by poor insulation due to weathering or damage by other objects.

9. Technical Parameters

| Technical Data | FSA-3K1P-BL | FSA-4K1P-BL |
|--|-----------------------|-------------|
| Solar Input Data | | |
| Max. PV Input Power | 3300W | 4400W |
| Max. Input Voltage | 500V | |
| Start-up Voltage | 90V | |
| MPPT Voltage Range | 60V~450V | |
| Max. Input Current per MPPT | 18A | |
| Max. Short Circuit Current per MPPT | 23A | |
| Number of MPPT | 1 | |
| AC Input Data(Grid&Generator) | | |
| Nominal Input Voltage | 230Vac, L/N/PE | |
| Input Voltage Range | 90~280Vac | |
| Max. Input Current | 25A | |
| Nominal Input Power | 5700W | |
| AC Frequency Range | 50/60Hz(Auto sensing) | |
| Battery Data | | |
| Battery Type | Li-Ion/Lead-acid | |
| Nominal Battery Voltage | 24V | |
| Battery Voltage Range | 21~30V | |
| Max. Discharge Current | 137A | 137A |
| Max. Charge/Discharge Power | 3000 | 3300 |
| Li-Ion Battery Activation | Yes | |
| Li-Ion Battery Communication | CAN/RS485 | |
| Max. Solar Charge Current | 120A | 120A |
| Max. AC Charge Current | 100A | 100A |
| Max. Charge Current (PV+AC) | 120A | 120A |
| Inverter Output Data | | |
| Nominal Output Power | 3000W | 4000W |
| Peak Apparent AC Power | 6000VA | 8000VA |

| | | |
|-----------------------------|---|-------|
| Nominal AC Voltage | 230V | |
| Nominal Grid Frequency | 50/60Hz | |
| Voltage Waveform | Pure Sine wave | |
| Transfer Time | 10ms | |
| Max. Output Current | 16A | 18.3A |
| Overload Protection | 30s@102%-110% load; 10s@110%-130% load; 5s@130%-150% load; 200ms@≥150%load | |
| THDv (@linear load) | <3% | |
| Efficiency | | |
| Peak Efficiency | 94% | |
| MPPT Efficiency | ≥99.9% | |
| Protection | | |
| DC Surge Protection | Yes | |
| AC Surge Protection | Yes | |
| AC Short circuit Protection | Yes | |
| System Parameters | | |
| Dimension (W*H*D) | 290*424*120mm | |
| Weight | 7.15kg | |
| Relative Humidity | 5%~95% (Non-condensing) | |
| Operating Temperature Range | -10°C~60°C | |
| Noise Emission | ≤50dB | |
| Altitude | 2000m | |
| Cooling Method | Fan Cooling | |
| Ingress Protection | IP20 | |
| Characteristic | | |
| Number of AC Output | 2 | |
| Display | LCD&APP | |
| Communication Interface | RS485/ USB /CAN/ Wi-Fi | |
| Parallel Capability | 9 (optional) | |